

Basic Electronics

LECTURE NOTES

Branch: CSE

Semester: Second

Subject Teacher :

Vishwajeet Singh, Lecturer Electronics

**Mahamaya Polytechnic of Information
Technology, Salempur, Hathras**

Semiconductor —I

- Materials that permit flow of electrons are called conductors (e.g., gold, silver, copper, etc.).
- Materials that block flow of electrons are called insulators (e.g., rubber, glass, Teflon, mica, etc.).
- Materials whose conductivity falls between those of conductors and insulators are called semiconductors.
- Semiconductors are “part-time” conductors whose conductivity can be controlled.

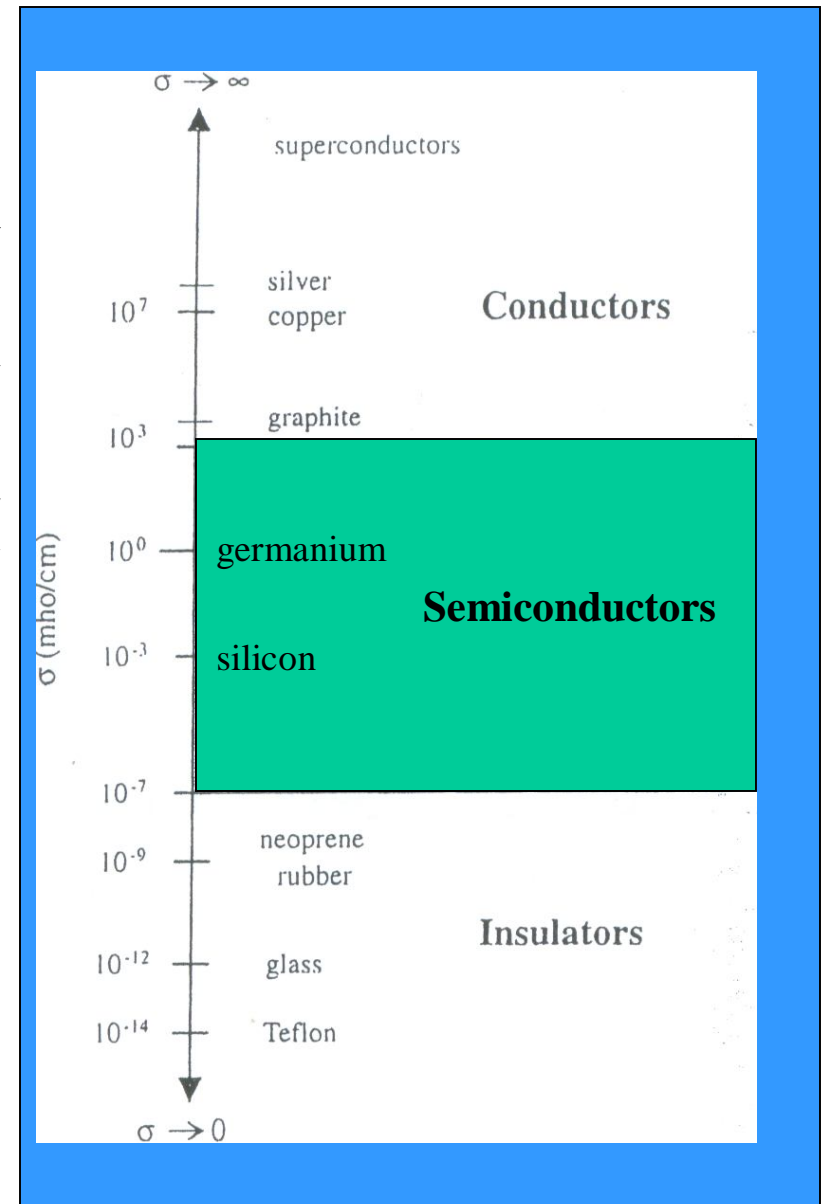

Semiconductor —II

- Silicon is the most common material used to build semiconductor devices.
- Si is the main ingredient of sand and it is estimated that a cubic mile of seawater contains 15,000 tons of Si.
- Si is spun and grown into a crystalline structure and cut into wafers to make electronic devices.

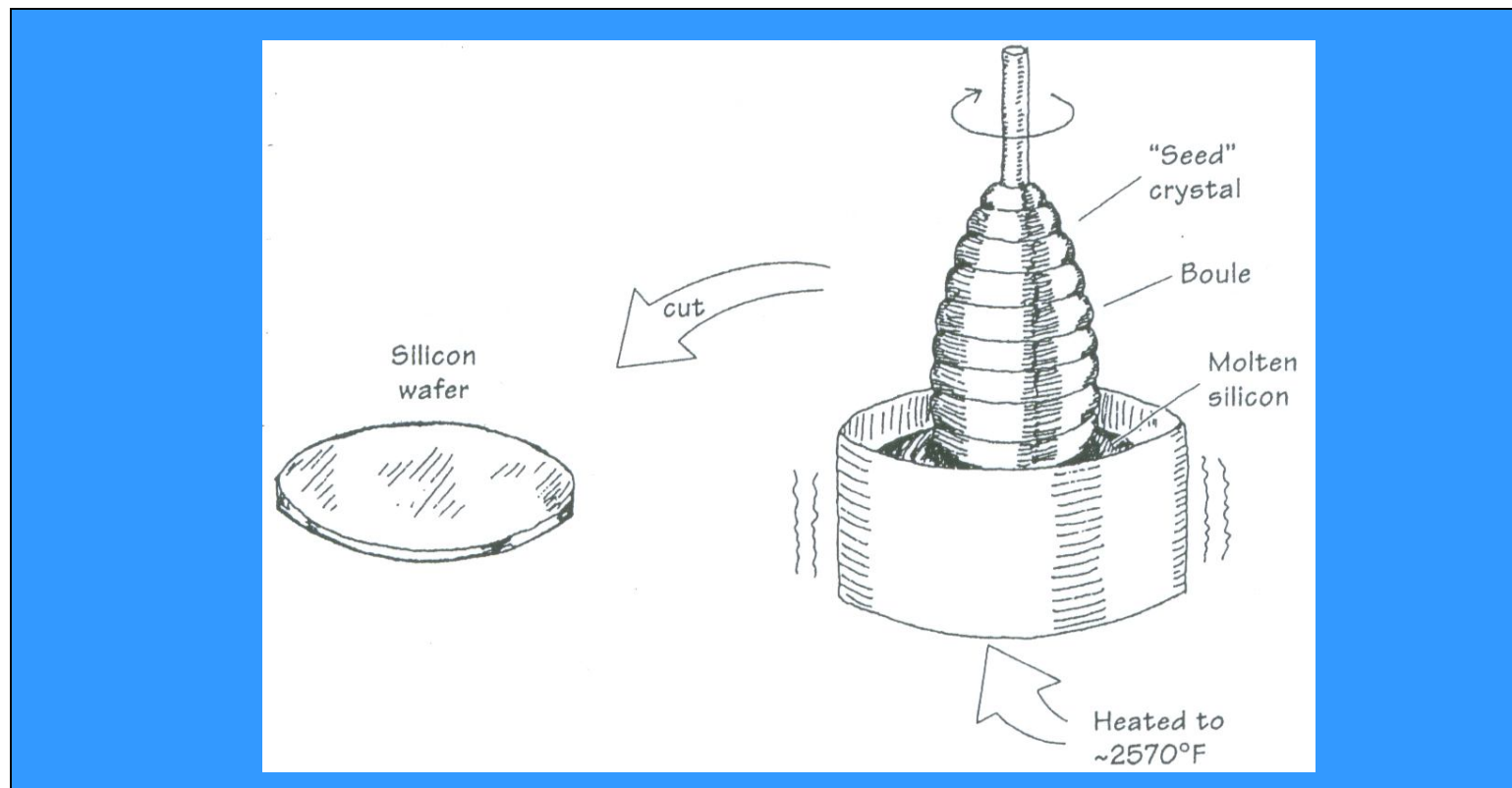

Semiconductor —III

- Atoms in a pure silicon wafer contains four electrons in outer orbit (called valence electrons).
 - Germanium is another semiconductor material with four valence electrons.
- In the crystalline lattice structure of Si, the valence electrons of every Si atom are locked up in covalent bonds with the valence electrons of four neighboring Si atoms.
 - In pure form, Si wafer does not contain any free charge carriers.
 - An applied voltage across pure Si wafer does not yield electron flow through the wafer.
 - A pure Si wafer is said to act as an insulator.
- In order to make useful semiconductor devices, materials such as phosphorus (P) and boron (B) are added to Si to change Si's conductivity.

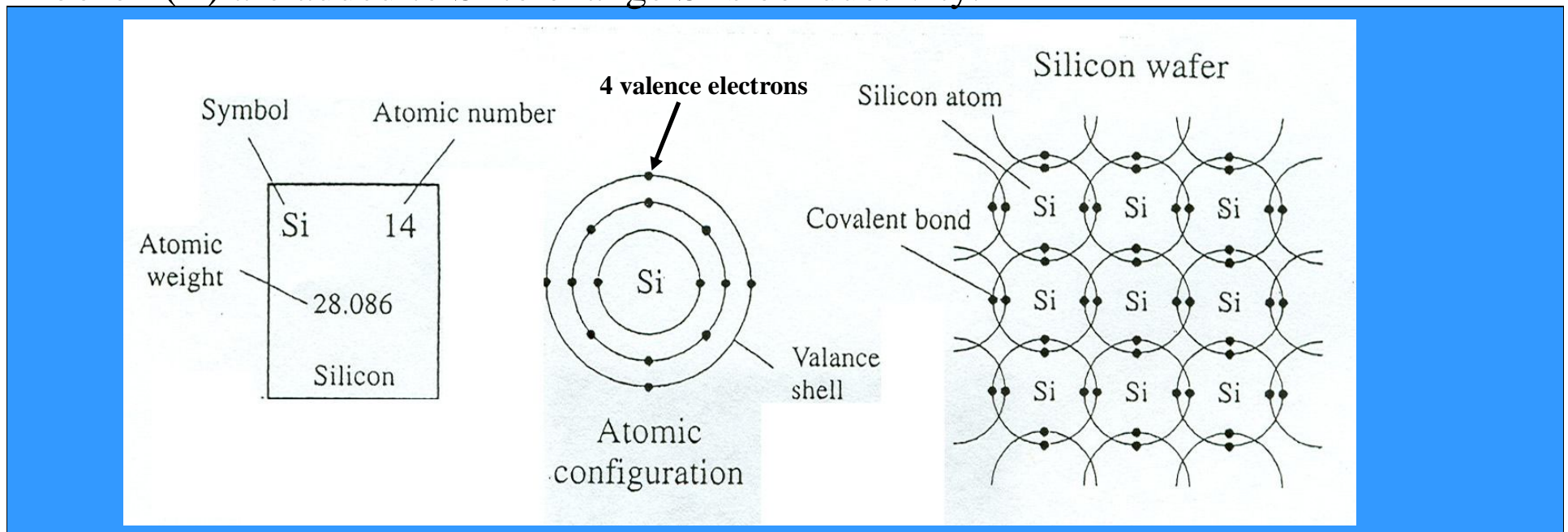

N-Type Silicon

- Pentavalent impurities such as phosphorus, arsenic, antimony, and bismuth have 5 valence electrons.
- When phosphorus impurity is added to Si, every phosphorus atom's four valence electrons are locked up in covalent bond with valence electrons of four neighboring Si atoms. However, the 5th valence electron of phosphorus atom does not find a binding electron and thus remains free to float. When a voltage is applied across the silicon-phosphorus mixture, free electrons migrate toward the positive voltage end.
- When phosphorus is added to Si to yield the above effect, we say that Si is doped with phosphorus. The resulting mixture is called N-type silicon (N: negative charge carrier silicon).
- The pentavalent impurities are referred to as donor impurities.

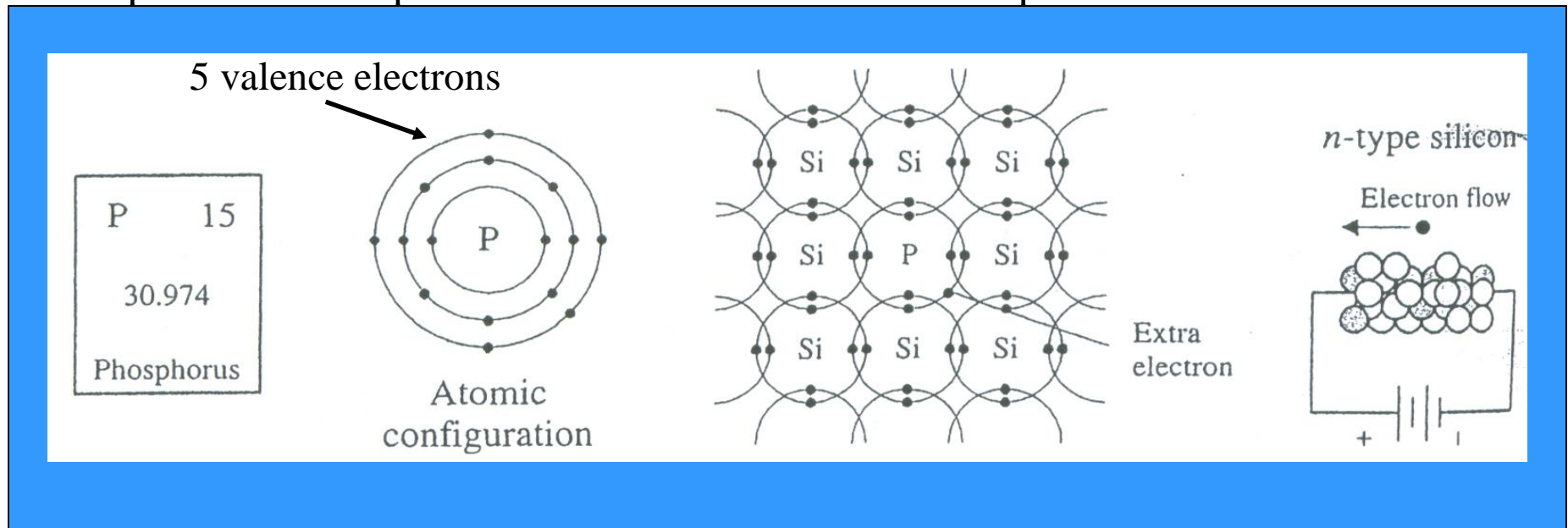

P-Type Silicon —I

- Trivalent impurities e.g., boron, aluminum, indium, and gallium have 3 valence electrons.
- When boron is added to Si, every boron atom's three valence electrons are locked up in covalent bond with valence electrons of three neighboring Si atoms. However, a vacant spot "hole" is created within the covalent bond between one boron atom and a neighboring Si atom. The holes are considered to be positive charge carriers. When a voltage is applied across the silicon-boron mixture, a hole moves toward the negative voltage end while a neighboring electron fills in its place.
- When boron is added to Si to yield the above effect, we say that Si is doped with boron. The resulting mixture is called P-type silicon (P: positive charge carrier silicon).
- The trivalent impurities are referred to as acceptor impurities.

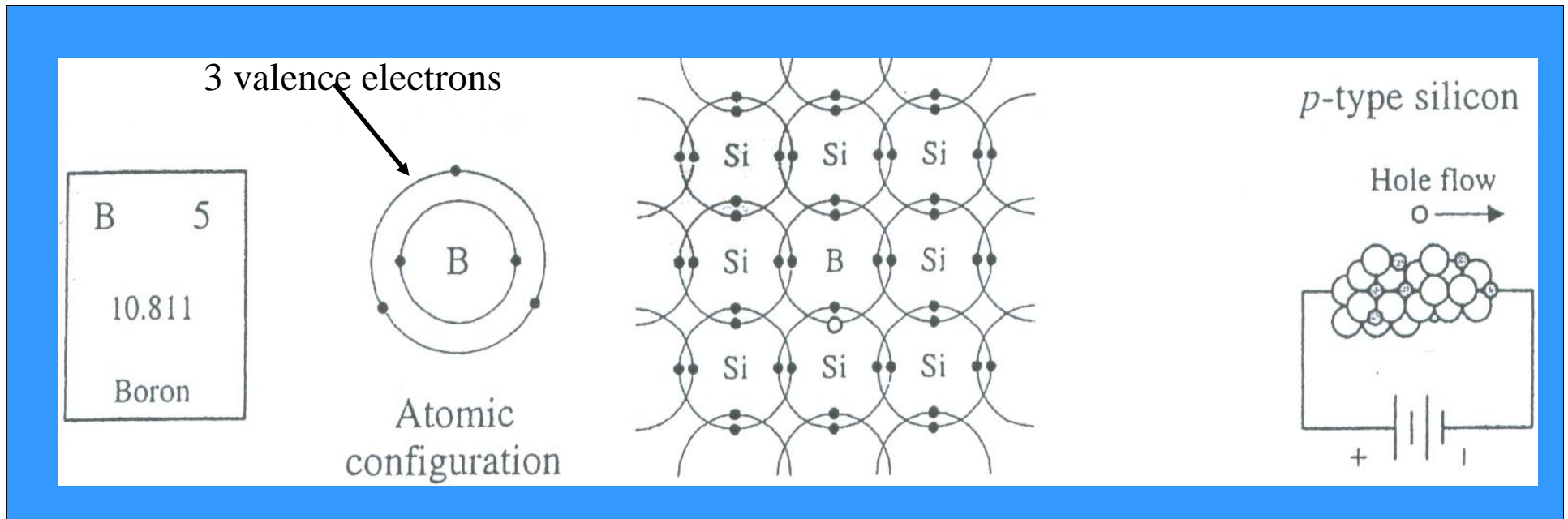

P-Type Silicon —II

- The hole of boron atom points towards the negative terminal.
- The electron of neighboring silicon atom points toward positive terminal.
- The electron from neighboring silicon atom falls into the boron atom filling the hole in boron atom and creating a “new” hole in the silicon atom.
- It appears as though a hole moves toward the negative terminal!

Diode

- A diode is a 2 lead semiconductor that acts as a one way gate to electron flow.
 - Diode allows current to pass in only one direction.
- A pn-junction diode is formed by joining together n-type and p-type silicon.
- In practice, as the n-type Si crystal is being grown, the process is abruptly altered to grow p-type Si crystal. Finally, a glass or plastic coating is placed around the joined crystal.
- The p-side is called anode and the n-side is called cathode.
- When the anode and cathode of a pn-junction diode are connected to external voltage such that the potential at anode is higher than the potential at cathode, the diode is said to be forward biased.
 - In a forward-biased diode current is allowed to flow through the device.
- When potential at anode is smaller than the potential at cathode, the diode is said to be reverse biased. In a reverse-biased diode current is blocked.

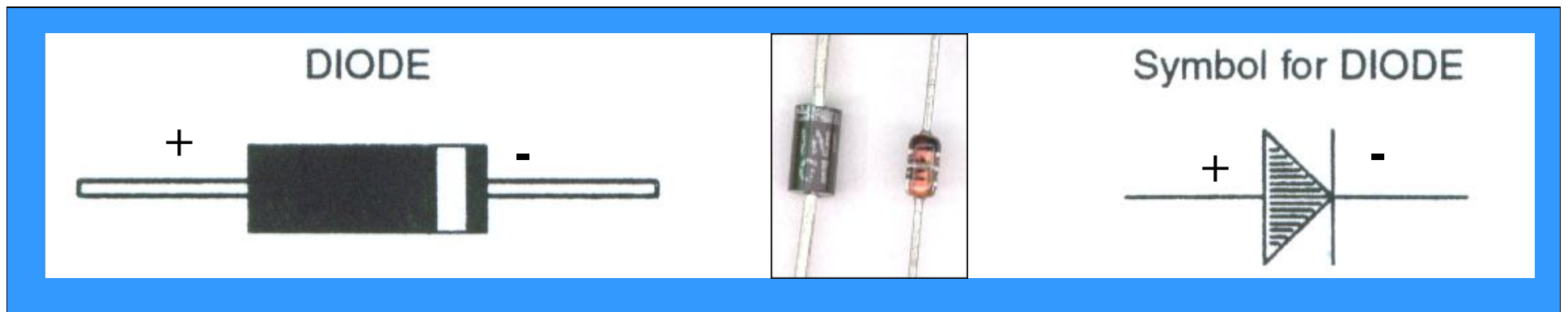

Water Analogy of Diodes

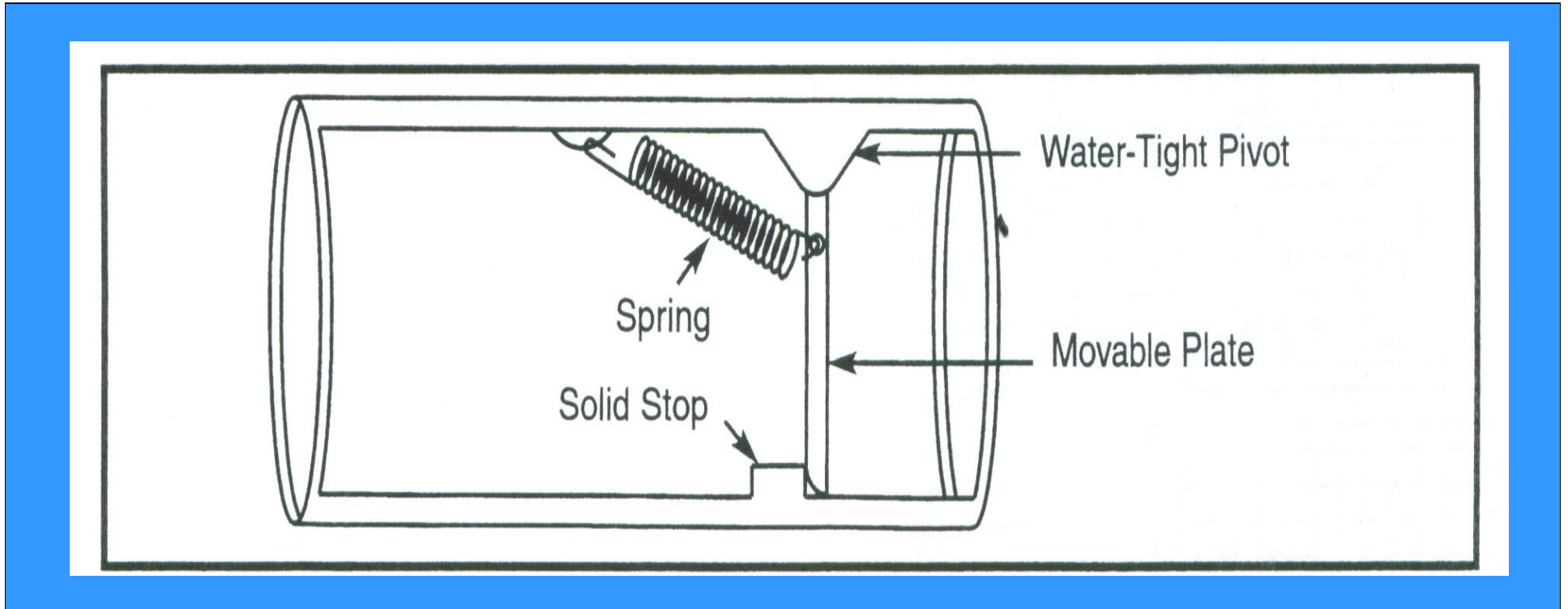

- When water pressure on left overcomes the restoring force of spring, the gate is opened and water is allowed to flow →.
- When water pressure is from right to left, the gate is pressed against the solid stop and no water is allowed to flow.
- Spring restoring force is analogous to 0.6V needed to forward bias a Si diode.

Diode: How it Works —I

- When a diode is connected to a battery as shown, electrons from the n-side and holes from the p-side are forced toward the center by the electrical field supplied by the battery. The electrons and holes combine causing the current to pass through the diode. When a diode is arranged in this way, it is said to be forward-biased.

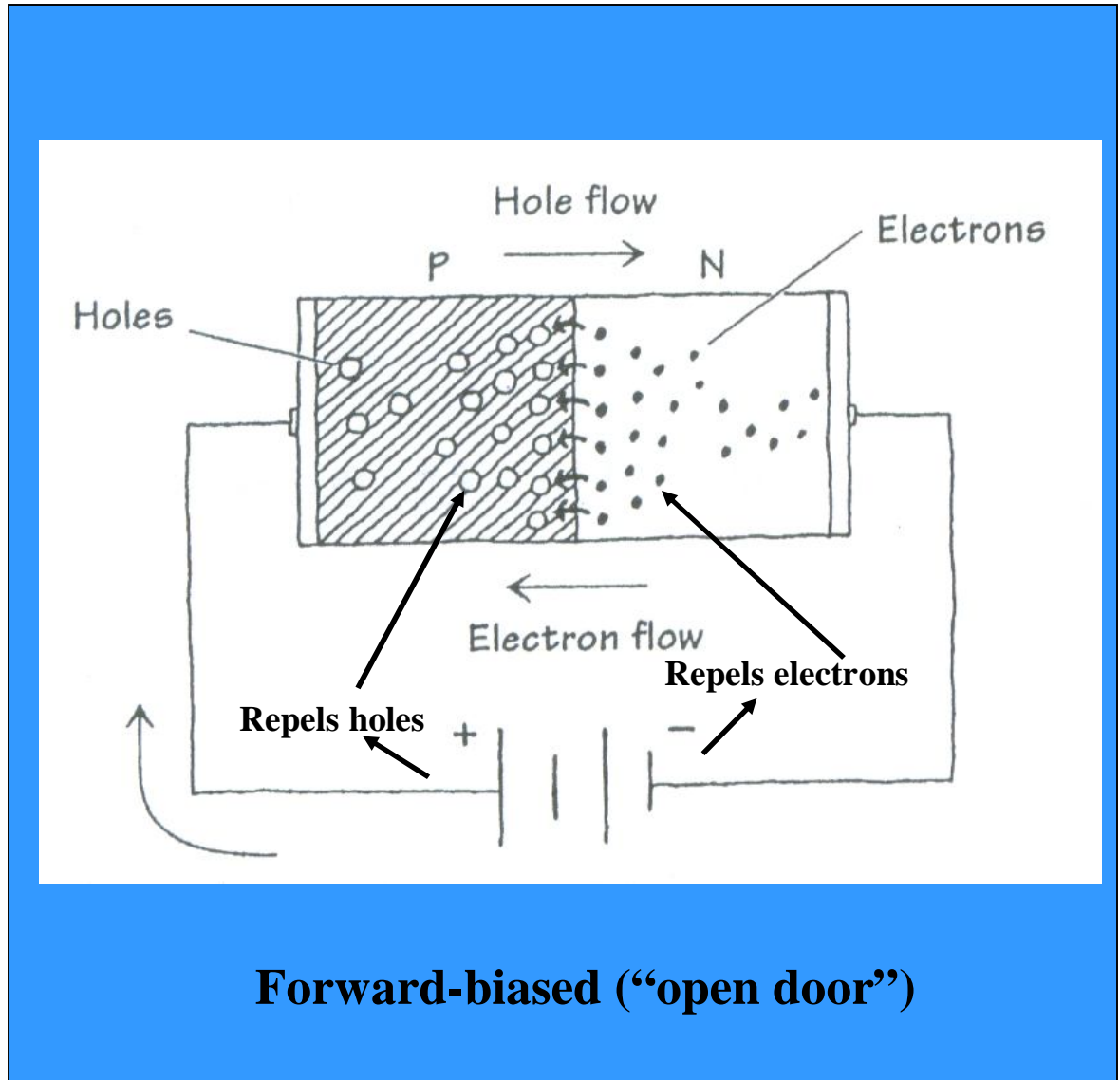

Diode: How it Works—II

- A diode's one-way gate feature does not work all the time.
- Typically for silicon diodes, an applied voltage of 0.6V or greater is needed, otherwise, the diode will not conduct.
- This feature is useful in forming a voltage-sensitive switch.
- I-V characteristics for silicon and germanium diodes is shown below.

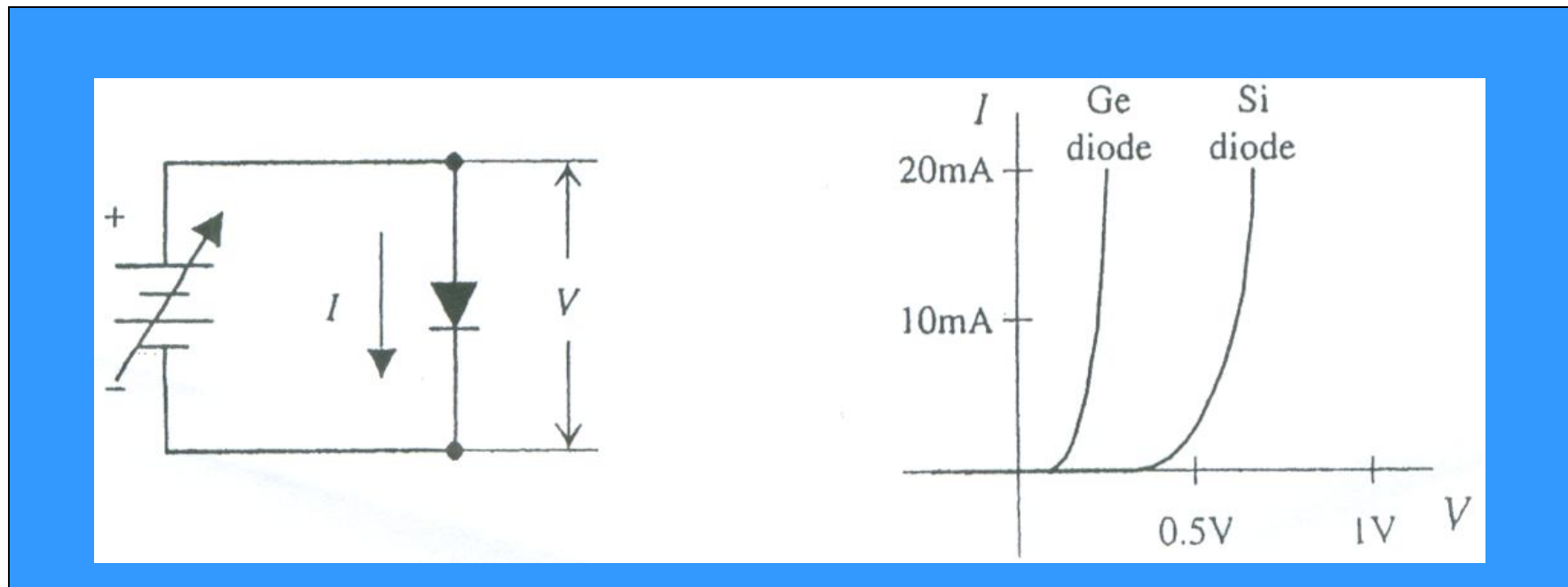

Diode: How it doesn't work

- When a diode is connected to a battery as shown, holes in the n-side are forced to the left while electrons in the p-side are forced to the right. This results in an empty zone around the pn-junction that is free of charge carriers creating a **depletion region**. This depletion region acts as an insulator preventing current from flowing through the diode. When a diode is arranged in this way, it is said to be reverse-biased.

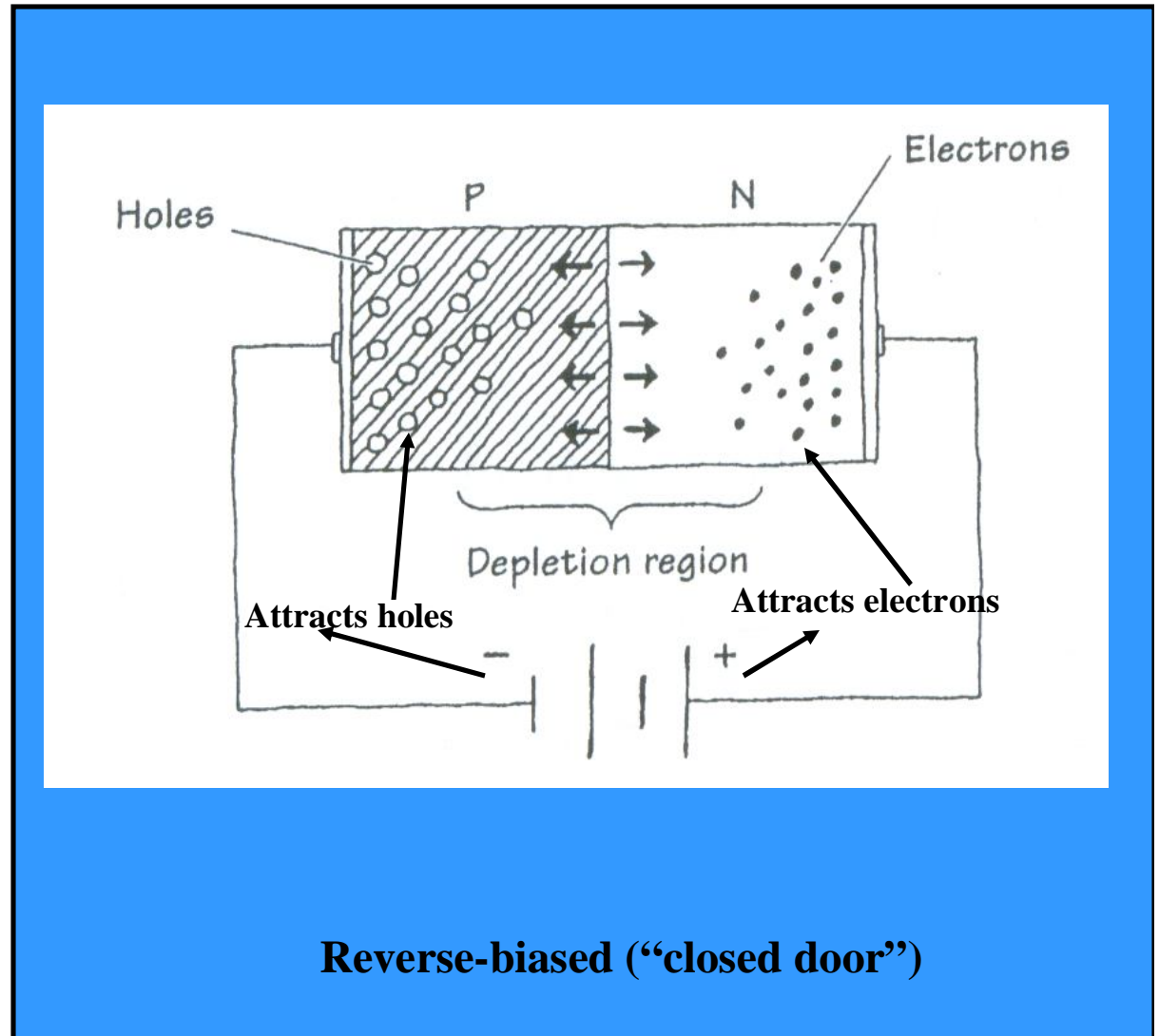

Diode Applications — Half Wave Rectifier

- Diode converts ac input voltage to a pulsed dc output voltage.
- Whenever the ac input becomes negative at diode's anode, the diode blocks current flow.
 - o/p voltage become zero.
- Diode introduces a 0.6V drop so o/p peak is 0.6V smaller than the i/p peak.
- The o/p frequency is same as the i/p frequency.

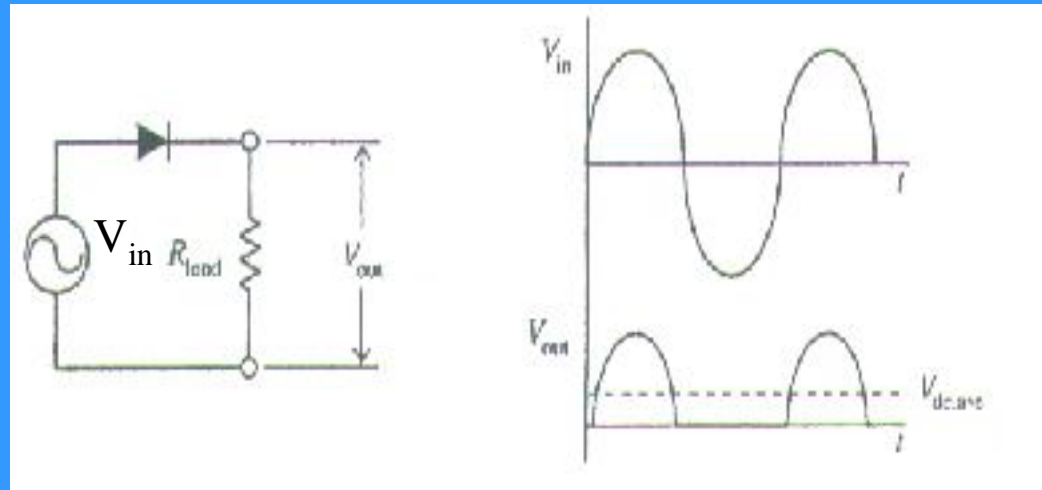

Diode Applications — Full Wave Rectifier

- A full-wave rectifier does not block negative swings in the i/p voltage, rather it transforms them into positive swings at the o/p.
- To gain an understanding of device operation, follow current flow through pairs of diodes in the bridge circuit.
- It is easily seen that one pair (D3-R_{out}-D2) allows current flow during the +ve half cycle of V_{in} while the other pair (D4-R_{out}-D1) allows current flow during the -ve half cycle of V_{in} .
 - → o/p voltage peak is 1.2V below the i/p voltage peak.
 - The o/p frequency is twice the i/p frequency.

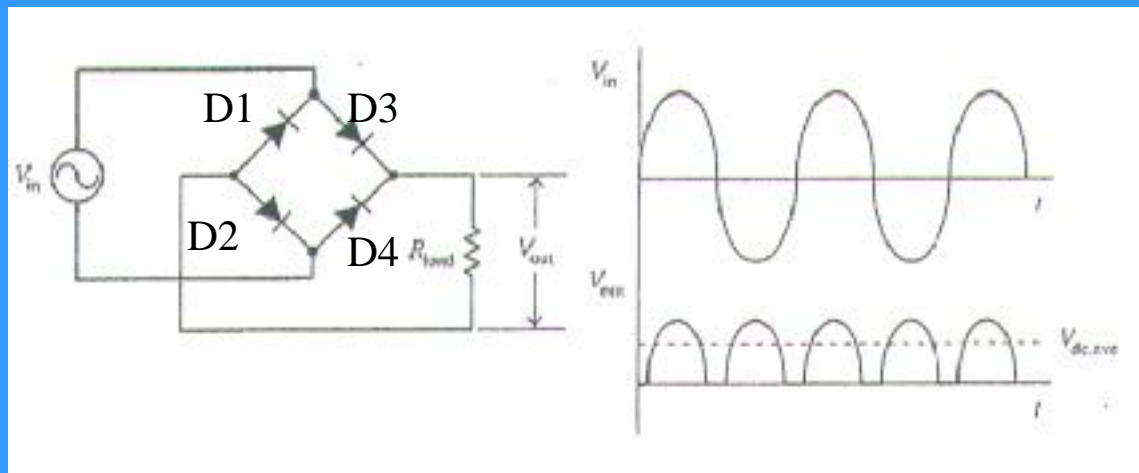

Diode Applications — AC2DC Power Supply

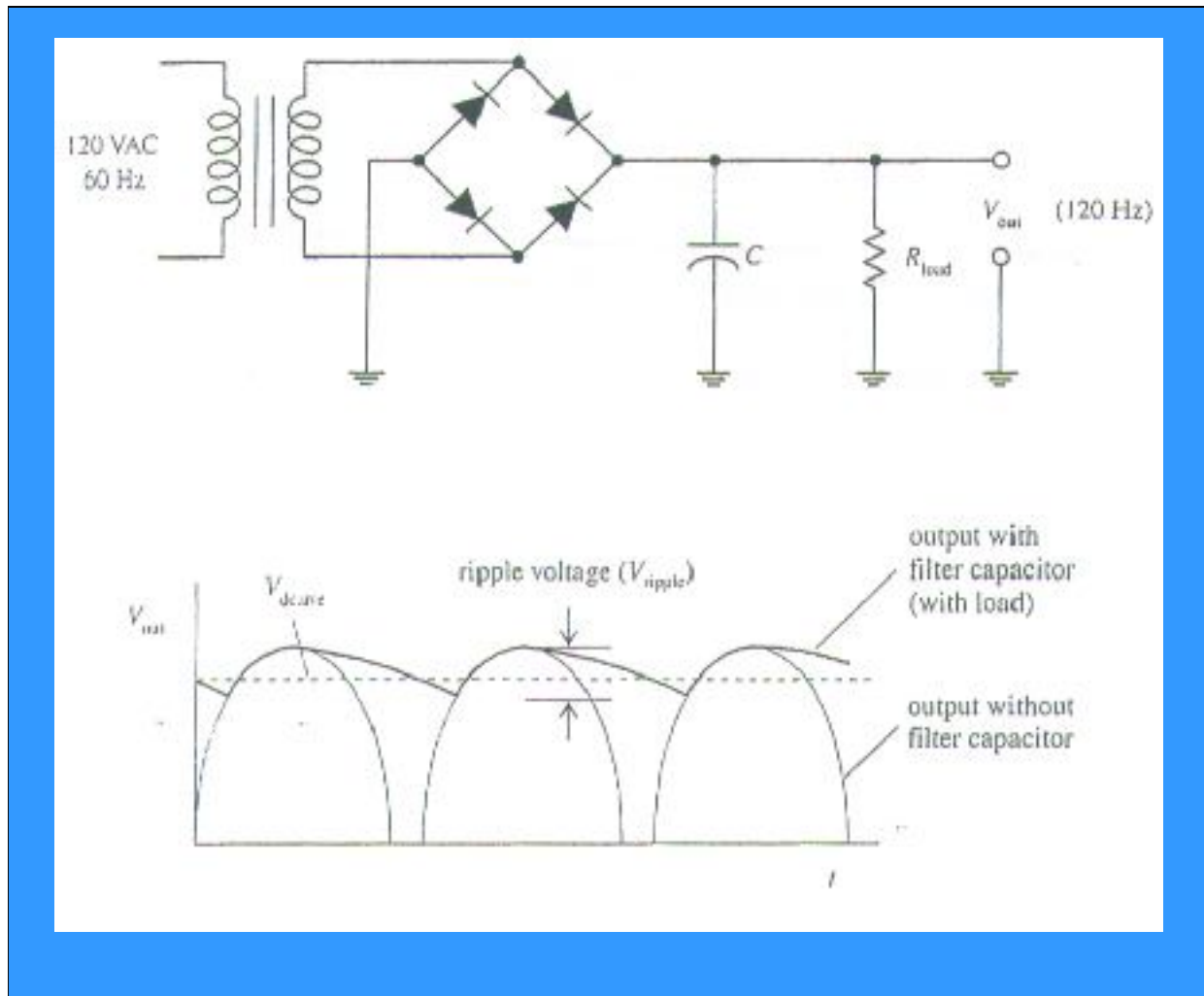

- An AC2DC power supply is built using a transformer and a full-wave rectifier.
- Transformer is used to step down the voltage i/p.
- Rectifier converts AC to pulsed DC.
- A filter capacitor is used to smooth out the pulses.
- Capacitor must be large enough to store sufficient charge so as to provide a steady current supply to the load:

$$R_{Load} C \gg 1/f$$

f is rectified signal's frequency (120Hz).

Transistor

- A three lead semiconductor device that acts as:
 - an electrically controlled switch, or
 - a current amplifier.
- Transistor is analogous to a faucet.
 - Turning faucet's control knob alters the flow rate of water coming out from the faucet.
 - A small voltage/current applied at transistor's control lead controls a larger current flow through its other two leads.

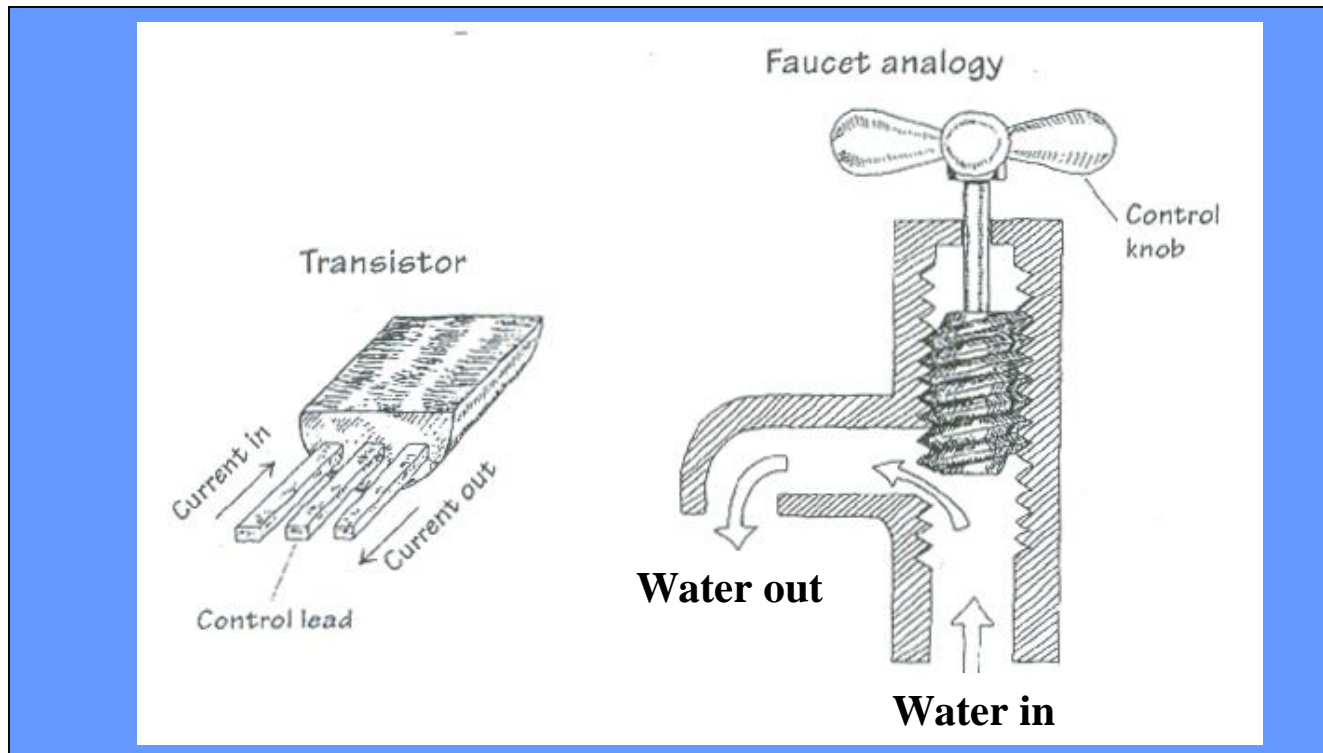

Transistor Types: BJT, JFET, and MOSFET

- **Bipolar Junction Transistor (BJT)**
 - NPN and PNP
- **Junction Field Effect Transistor (JFET)**
 - N-channel and P-channel
- **Metal Oxide Semiconductor FET (MOSFET)**
 - Depletion type (n- and p-channel) and enhancement type (n- and p-channel)



BJT

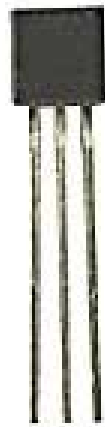

JFET



MOSFET

BJT Types

- NPN and PNP.
 - NPN: a small input current and a positive voltage applied @ its base (with $V_B > V_E$) allows a large current to flow from collector to emitter.
 - PNP: a small output current and a negative voltage @ its base (with $V_B < V_E$) allows a much larger current to flow from emitter to collector.

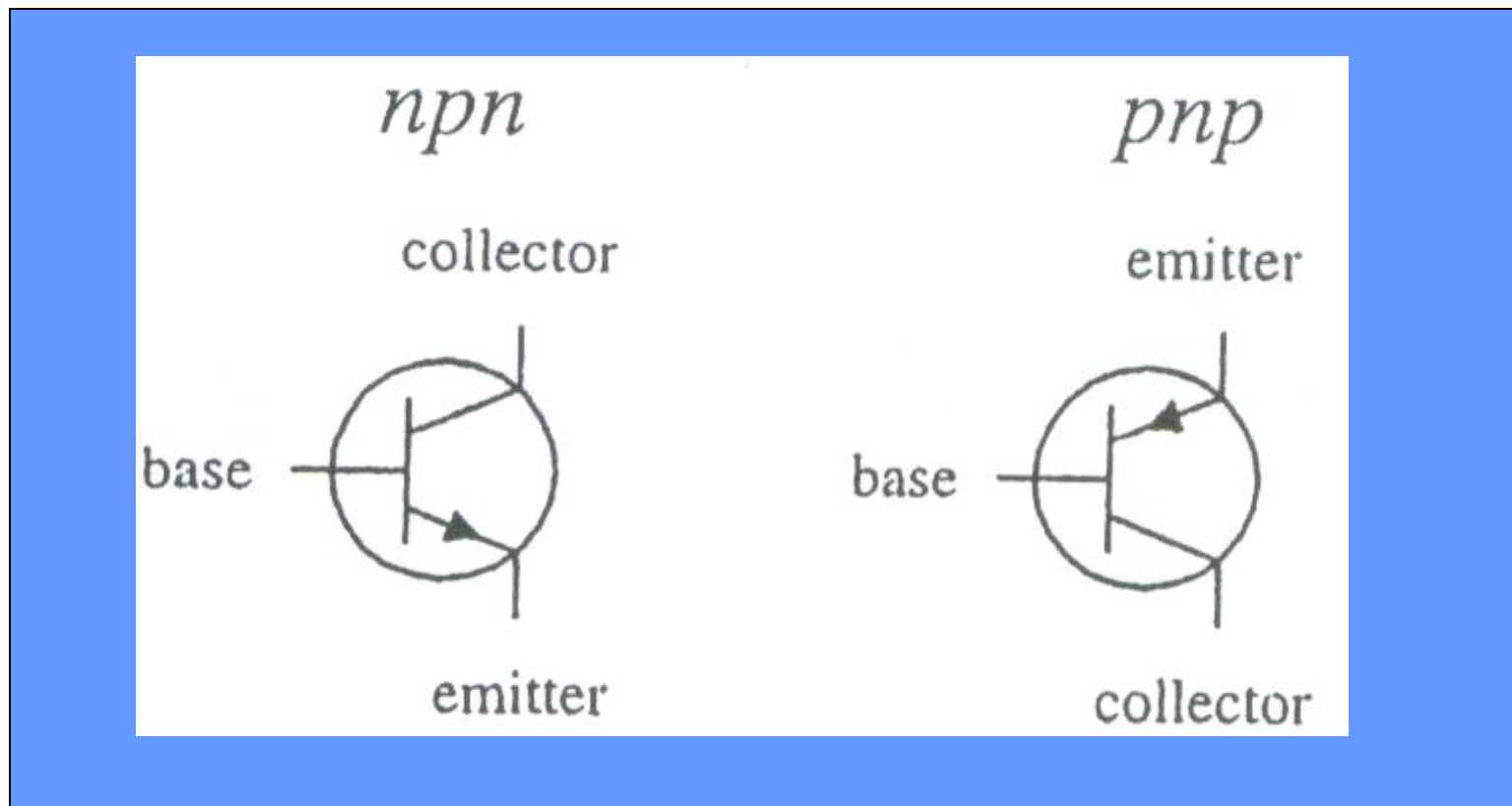

NPN BJT: How it works — I

- When no voltage is applied at transistor's base, electrons in the emitter are prevented from passing to the collector side because of the pn junction.
- If a negative voltage is applied to the base, things get even worse as the pn junction between the base and emitter becomes reverse-biased resulting in the formation of a depletion region that prevents current flow.

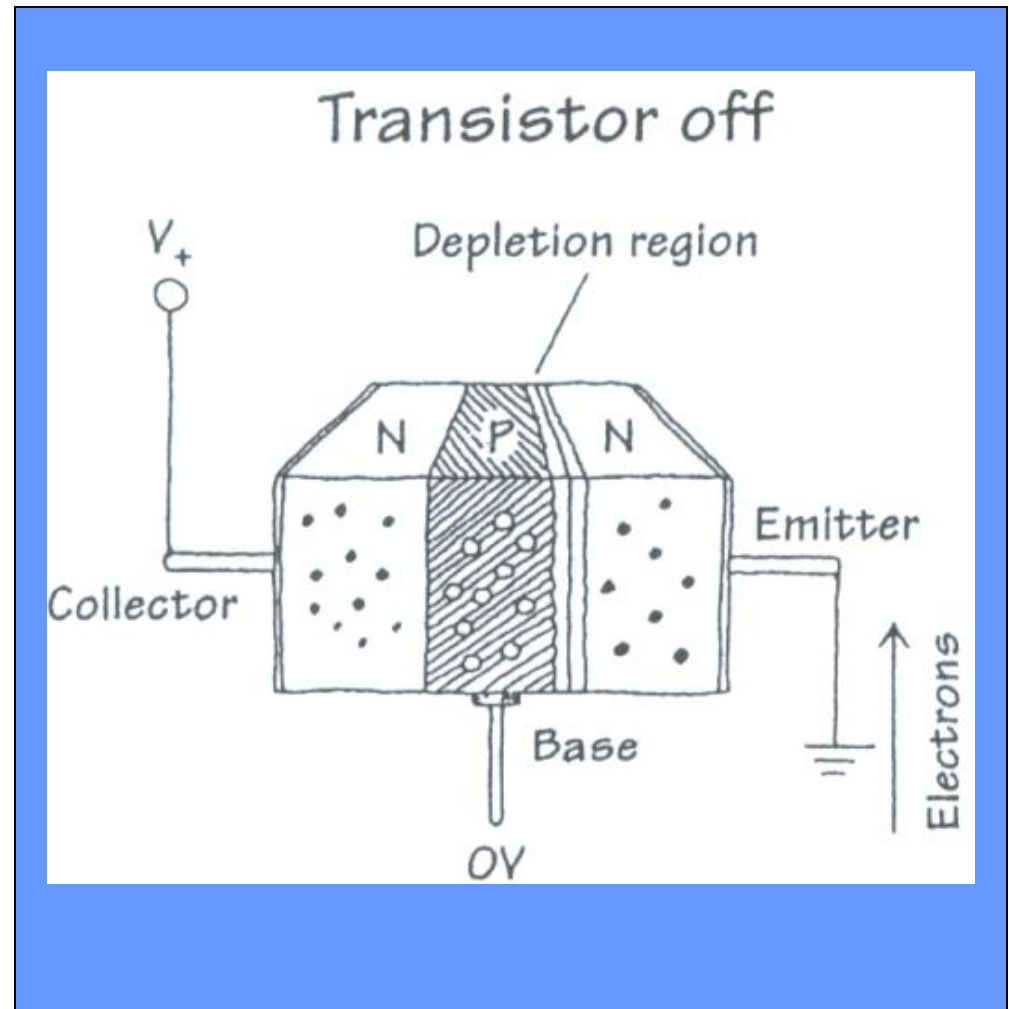

NPN BJT: How it works — II

- If a positive voltage ($>0.6V$) is applied to the base of an npn transistor, the pn junction between the base and emitter becomes forward-biased. During forward bias, escaping electrons are drawn to the positive base.
- Some electrons exit through the base, but because the p-type base is so thin, the onslaught of electrons that leave the emitter get close enough to the collector side that they begin jumping into the collector. Increasing the base voltage increases the emitter-to-collector electron flow.
- Recall, positive current flow is in the direction opposite to the electron flow → current flows from collector to emitter.

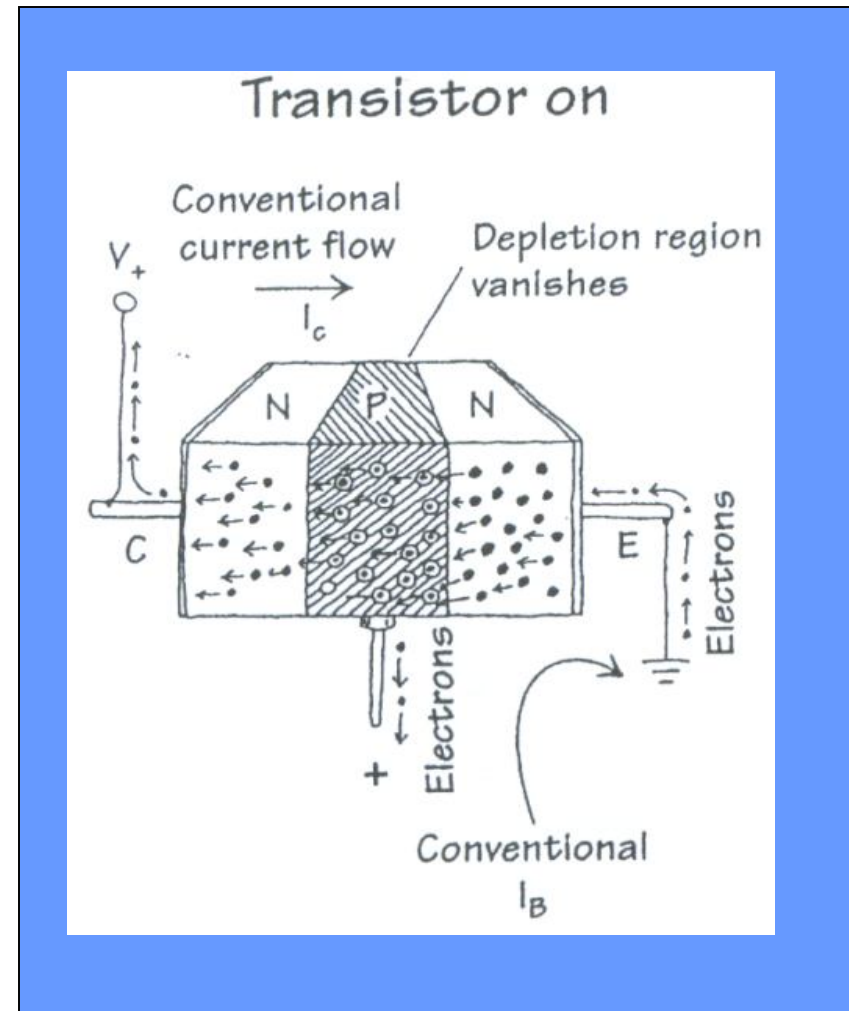

BJT Water Analogy

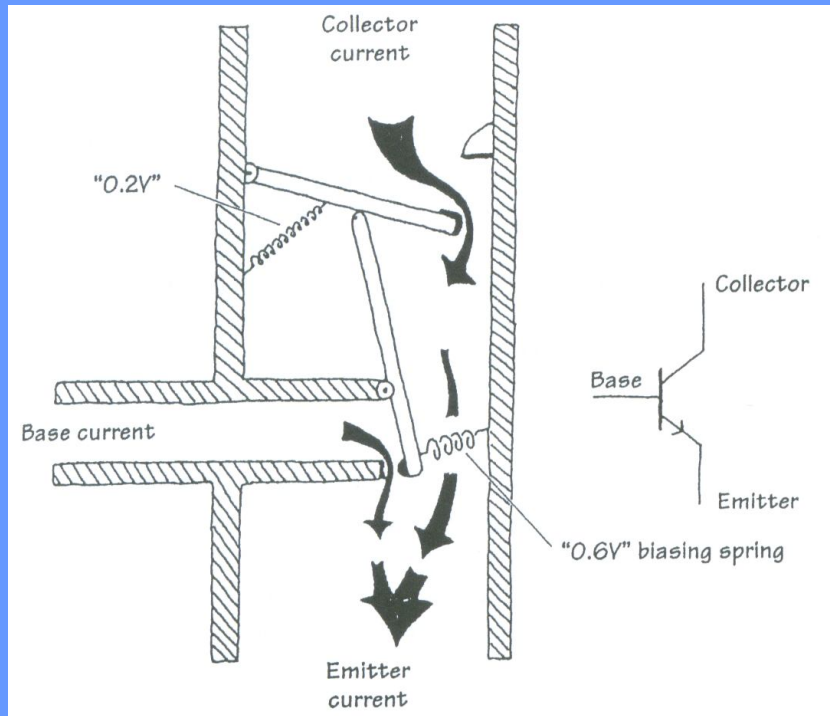

NPN ($V_B > V_E$)

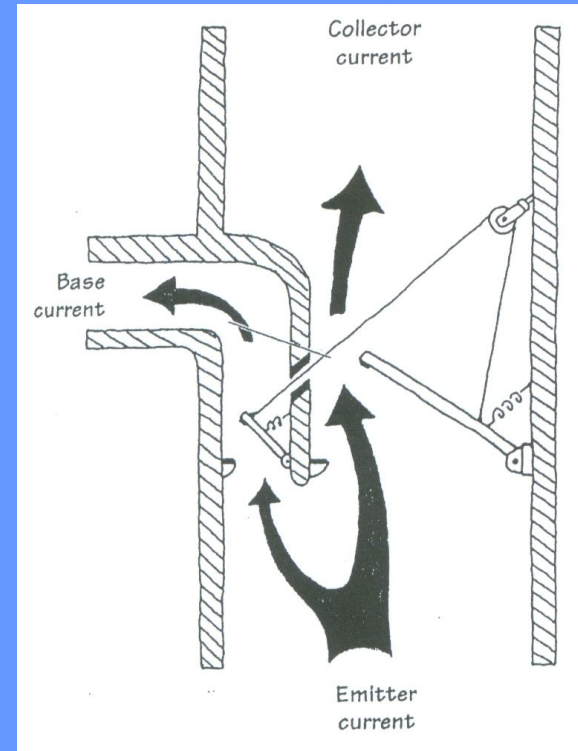

PNP ($V_B < V_E$)

NPN Transistor in a Complete Circuit —I

- Normally OFF.
- No current passes from collector to emitter when base is not activated.

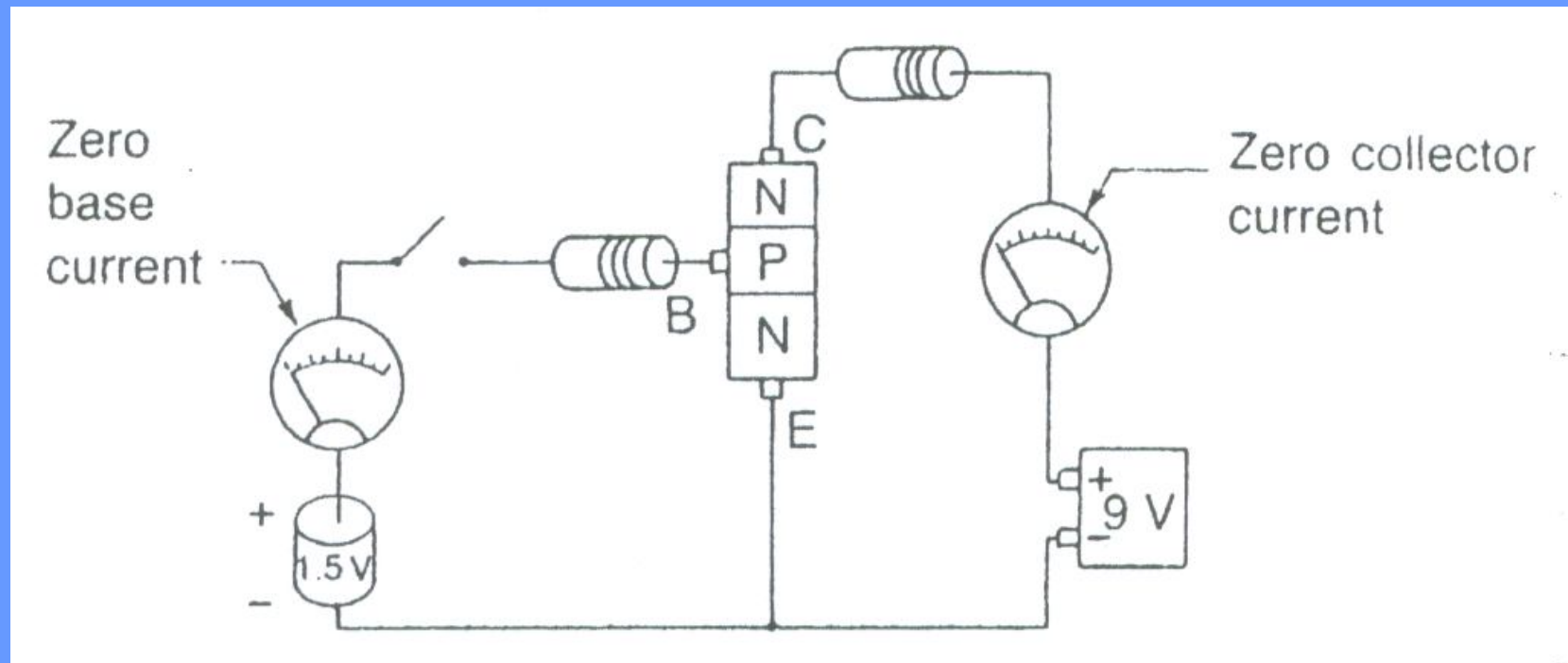

NPN: $V_B = V_E \rightarrow \text{OFF}$

NPN Transistor in a Complete Circuit —II

- When $V_B > V_E$ we have an operating circuit.
- Current passes from collector to emitter when base is activated.

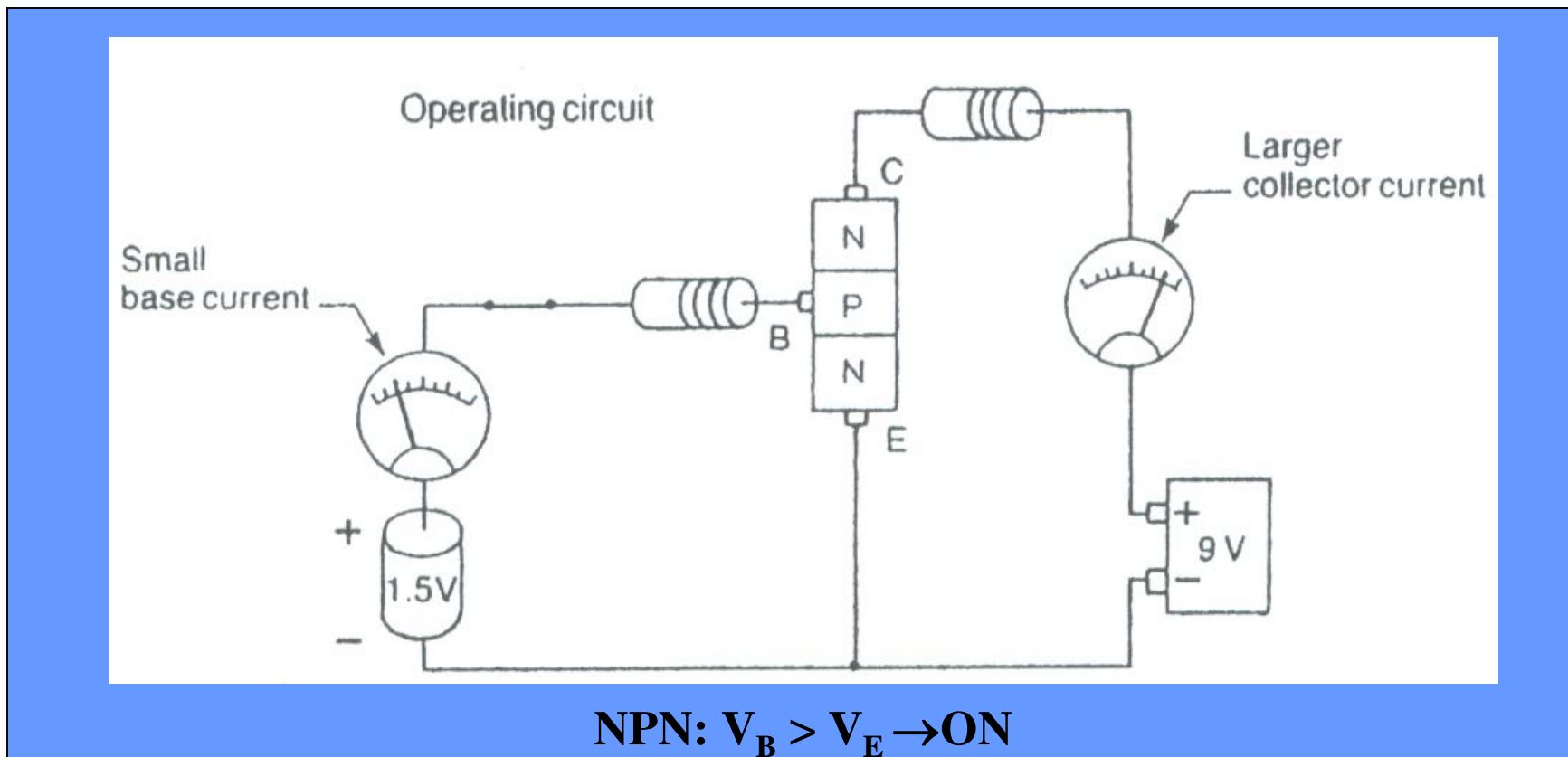

Transistor Experiment — LED On/Off

- Turning the switch on/off turns the LED on/off.

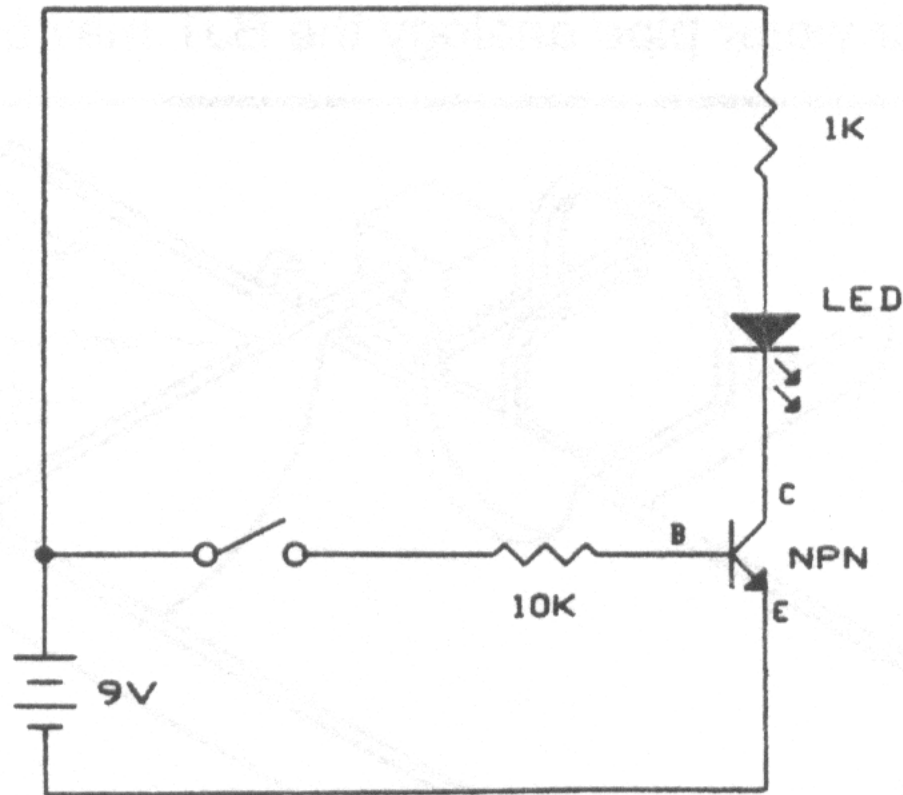

JFET

- Junction field effect transistors like BJTs are three lead semiconductor devices.
- JFETs are used as:
 - electrically controlled switches,
 - current amplifiers, and
 - voltage-controlled resistors.
- Unlike BJTs, JFETs do not require a bias current and are controlled by using only a voltage.
- JFETs are normally on when $V_G - V_S = 0$.
- When $V_G - V_S \neq 0$, then JFETs become resistive to current flow through the drain-source pair → “JFETs are depletion devices.”

JFET Types

- Two types of JFETs:
 - n-channel and p-channel.
- In n-channel JFET, a –ve voltage applied @ its gate (with $V_G < V_S$) reduces current flow from drain to source. It operates with $V_D > V_S$.
- In p-channel JFET, a +ve voltage applied @ its gate (with $V_G > V_S$) reduces current flow from source to drain. It operates with $V_S > V_D$.
- JFETs have very high input impedance and draw little or no input current
 - → if there is any circuit/component connected to the gate of a JFET, no current is drawn away from or sunk into this circuit.

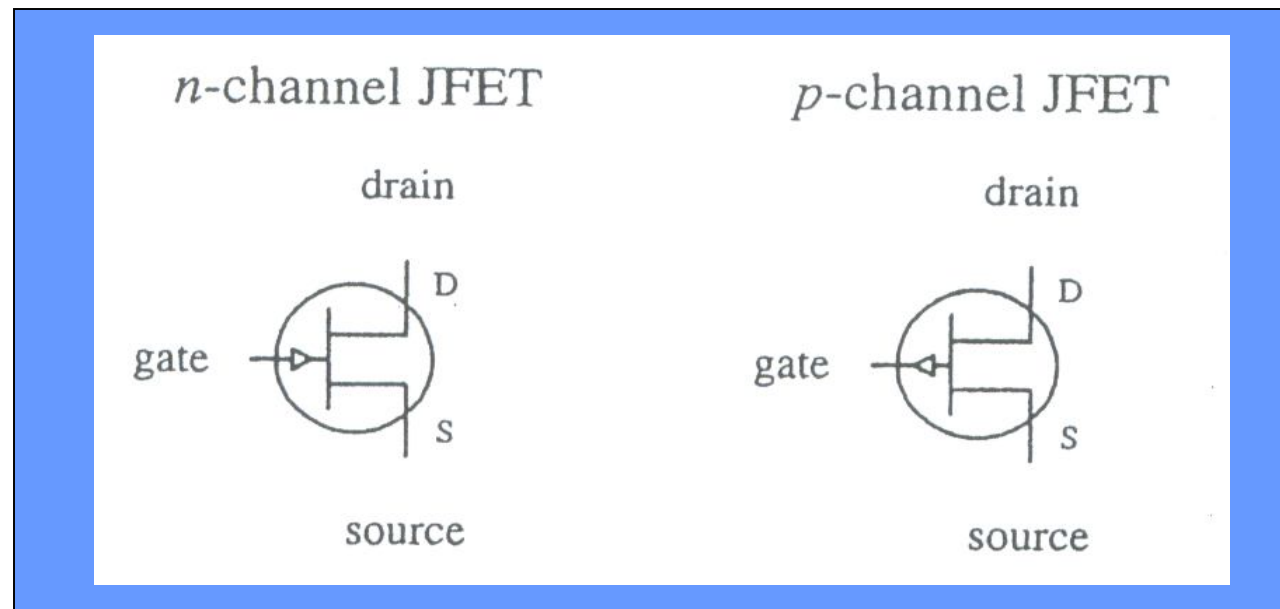

MOSFET

- Metal oxide semiconductor FET.
- Similar to JFET.
- A metal oxide insulator is placed @ the gate to obtain a high input impedance @ the gate
 - gate input impedance approx. $10^{14}\Omega$.
- Use of insulator as described above yields a low gate-to-channel capacitance.
 - If too much static electricity builds up on the gate, then the MOSFET may be damaged.



MOSFET Types

- Enhancement type:
 - Normally off, thus no current flows through drain-source channel when $V_G = V_S$.
 - When a voltage applied @ the gate causes $V_G \neq V_S$ the drain-source channel reduces resistance to current flow.
- Depletion type:
 - Normally on, thus maximum current flows through drain-source channel when $V_G = V_S$.
 - When a voltage applied @ the gate causes $V_G \neq V_S$ the drain-source channel increases resistance to current flow.

Enhancement MOSFETs

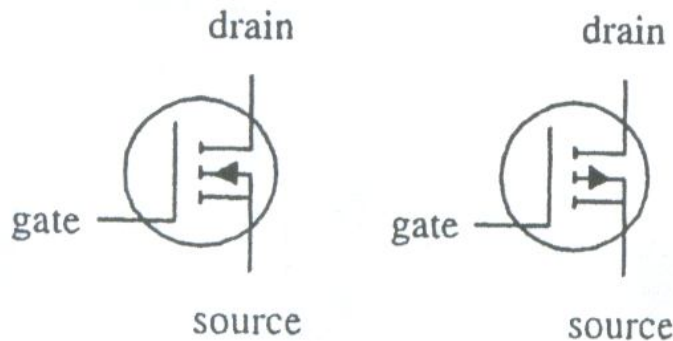

n-channel

p-channel

Current flow increases with:

$$V_G > V_S$$

$$V_G < V_S$$

Depletion MOSFETs

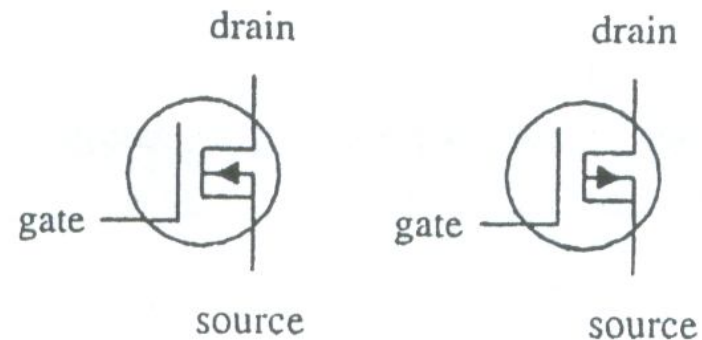

n-channel

p-channel

Current flow decreases with:

$$V_G < V_S$$

$$V_G > V_S$$

Optoelectronics

- In optoelectronics we deal with 2 types of electronic devices.
- Light emitting electronic devices: ones that generate electromagnetic energy under the action of electrical field. Example: light emitting diodes (visible and infrared light).
- Light detecting devices: ones that transform electromagnetic energy input into electrical current/voltage. Examples: photoresistors, photodiodes, phototransistors, etc.

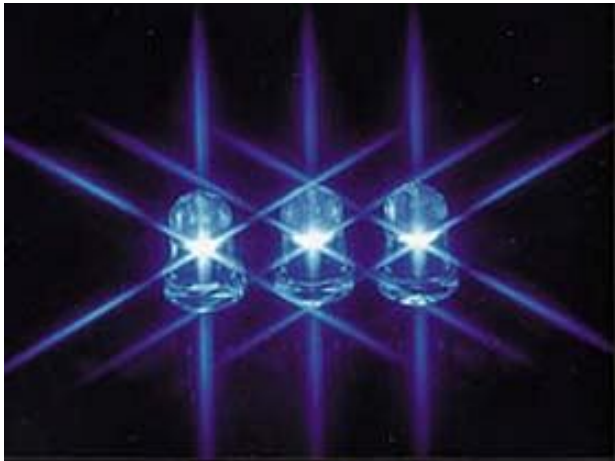

Light emitting diodes

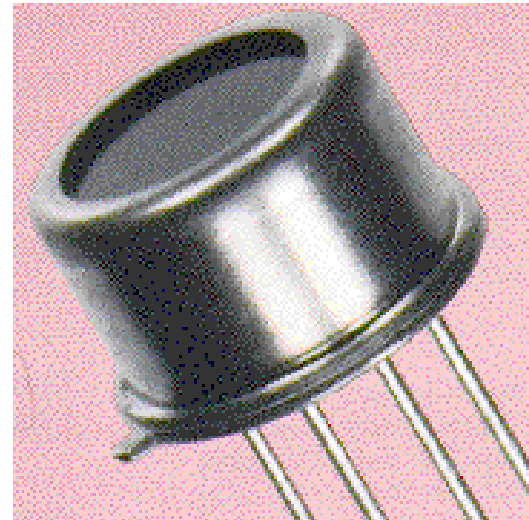

Infrared detector

Light-Emitting Diodes (LEDs)

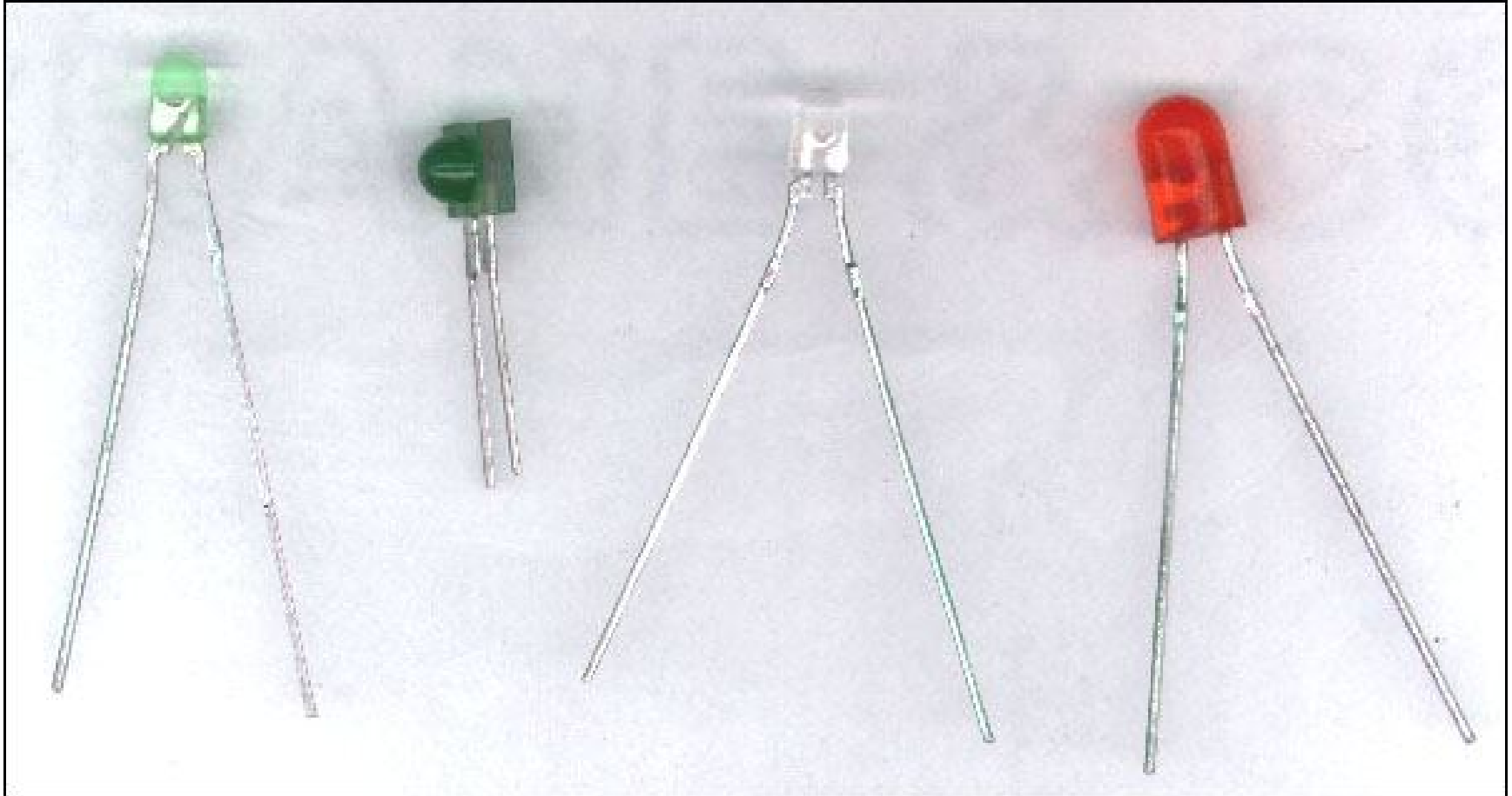

LED 101— I

- 2 lead semiconductor device.
- Light emitting PN-junction diode.
 - Visible or infrared light.
- Has polarity.
- Recall diodes act as a one way gate to current flow.
 - A forward-biased PN-junction diode allows current flow from anode to cathode.
- An LED conducts and emits light when its anode is made more positive (approx. 1.4V) than its cathode.
 - With reverse polarity, LED stops conducting and emitting light.

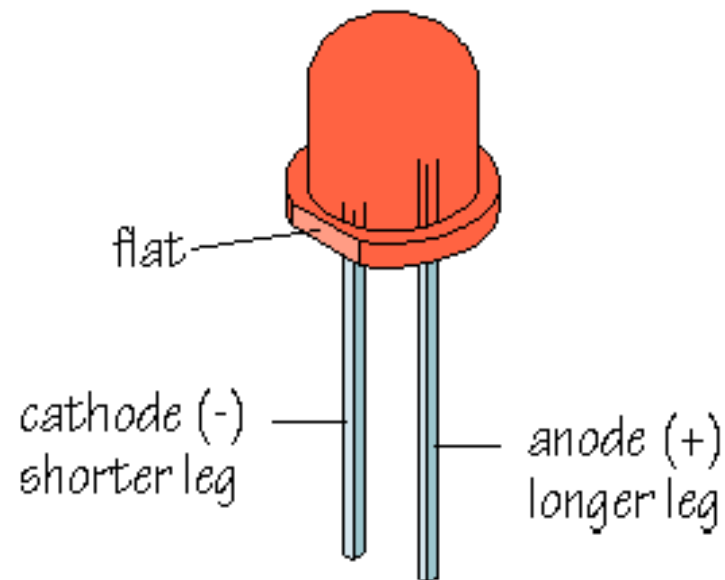

LED 101— II

- Similar to diodes, LEDs are current-dependent devices.
 - LED brightness is controlled by controlling current through LED.
 - Too little current through LED → LED remains OFF.
 - Small current through LED → dimly lit LED.
 - Large current through LED → brightly lit LED.
 - Too much current through LED → LED is destroyed.
- A resistor placed in series with LED accomplishes current control

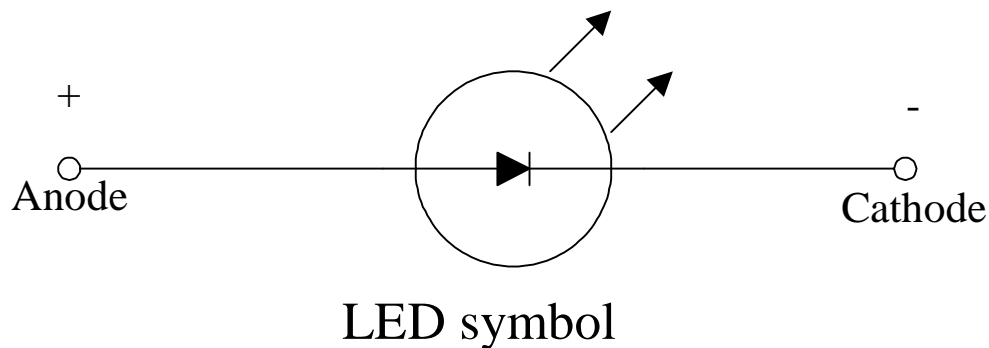

LED 101—III

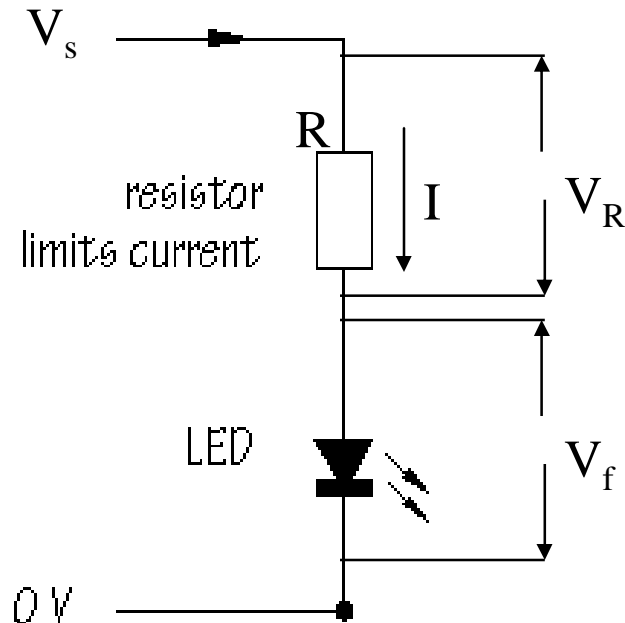

- Let V_s be the supply voltage.
- Let V_f be the required forward bias voltage for the LED.
- Let I be the desired current flow through LED.
- Then, the current limiting resistance R is sized as follow:

$$V_R = V_s - V_f$$

$$R = \frac{V_R}{I} = \frac{V_s - V_f}{I}$$

- If R is chosen smaller than the above value, a larger current will flow through the LED.
 - LEDs can handle only limited current (varies from 20mA to 100mA).
 - If current through LED is larger than the maximum allowed value, than the LED will be damaged.

Visible-Light LED

- Inexpensive and durable.
- Typical usage: as indicator lights.
- Common colors: green (~565nm), yellow (~585nm), orange (~615nm), and red (~650nm).
- Maximum forward voltage: $\approx 1.8\text{V}$.
- Typical operating currents: 1 to 3mA.
- Typical brightness levels: 1.0 to 3.0mcd/1mA to 3.0mcd /2mA.
- High-brightness LEDs exist.
 - Used in high-brightness flashers (e.g., bicycle flashers).



Blinking LED

- Contain a miniature integrated circuit that causes LED to flash from 1 to 6 times/second.
- Typical usage: indicator flashers. May also be used as simple oscillators.

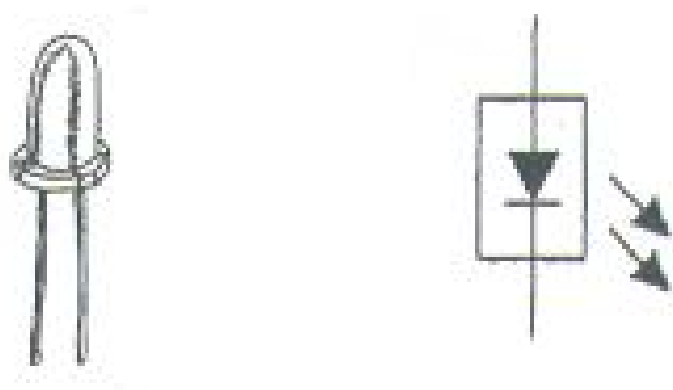

Tricolor LED

- Two LEDs placed in parallel facing opposite directions.
- One LED is red or orange, the other is green.
- Current flow in one direction turns one LED ON while the other remains OFF due to reverse bias.
- Current flow in the other direction turns the first LED OFF and the second LED ON.
- Rapid switching of current flow direction will alternatively turn the two LEDs ON giving yellow light.
- Used as a polarity indicator.
- Maximum voltage rating: 3V
- Operating range: 10 to 20mA

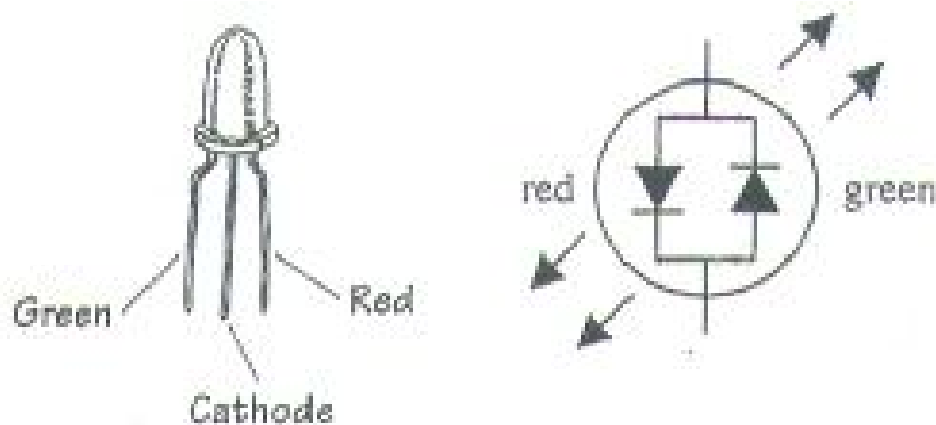

7-Segment LED Display

- Used for displaying numbers and other characters.
- 7 individual LEDs are used to make up the display.
- When a voltage is applied across one of the LEDs, a portion of the 8 lights up.
- Unlike liquid crystal displays (LCD), 7-segment LED displays tend to be more rugged, but they also consume more power.

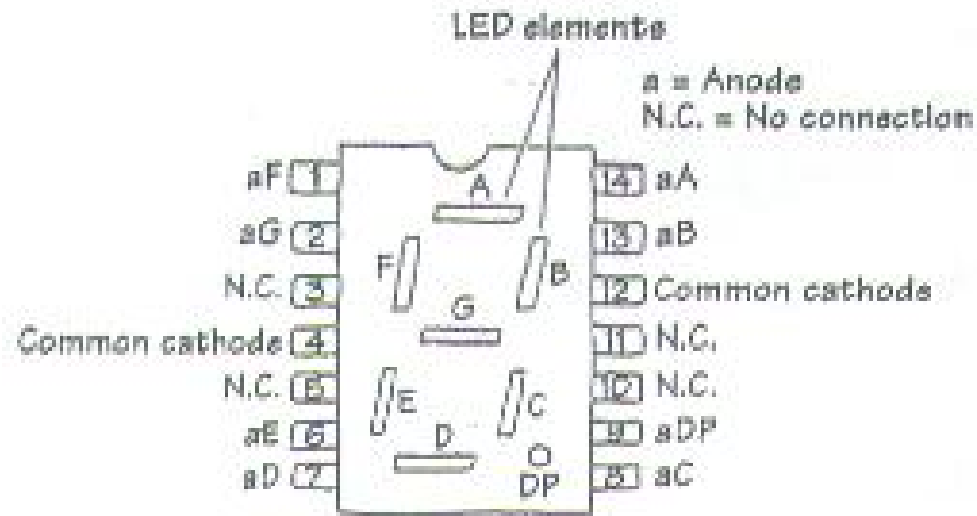

How LED Works

- The light-emitting section of an LED is made by joining n-type and p-type semiconductors together to form a pn junction.
- When the pn junction is forward-biased, electrons in the n side are excited across the pn junction and into the p side, where they combine with holes.
- As the electrons combine with the holes, photons are emitted.
- The pn-junction section of an LED is encased in an epoxy shell that is doped with light scattering particles to diffuse light and make the LED appear brighter.
- Often a reflector placed beneath the semiconductor is used to direct the light upward.

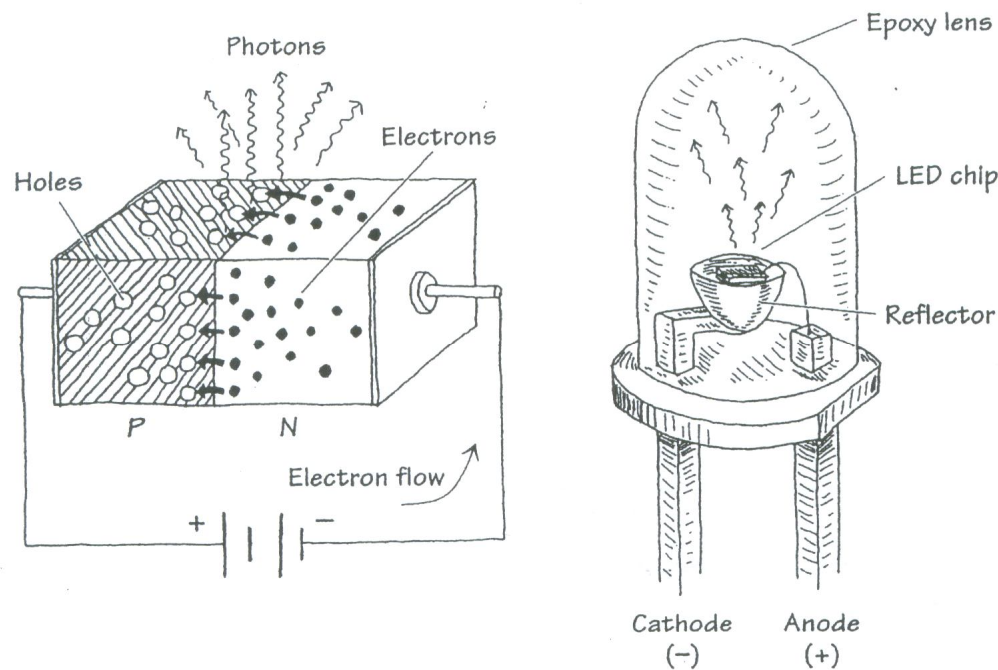

Photoresistors —I

- Light sensitive variable resistors.
- Its resistance depends on the intensity of light incident upon it.
 - Under dark condition, resistance is quite high ($M\Omega$: called dark resistance).
 - Under bright condition, resistance is lowered (few hundred Ω).
- Response time:
 - When a photoresistor is exposed to light, it takes a few milliseconds, before it lowers its resistance.
 - When a photoresistor experiences removal of light, it may take a few seconds to return to its dark resistance.

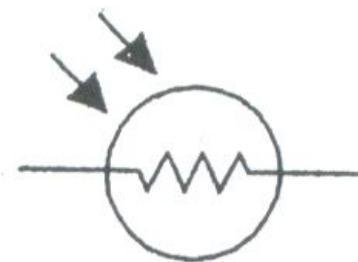
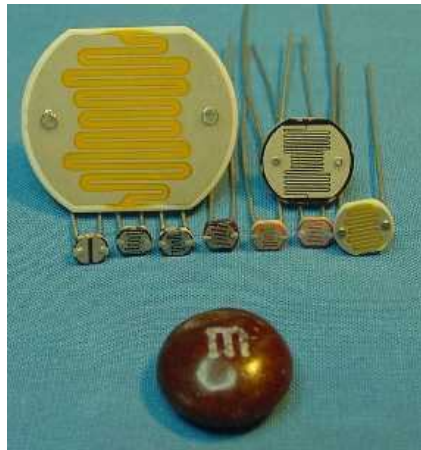

Symbol

Photoresistors —II

- Some photoresistors respond better to light that contains photons within a particular wavelength of spectrum.
 - Example: Cadmium-sulfide photoresistors respond to light within 400-800nm range.
 - Example: Lead-sulfide photoresistors respond to infrared light.

How Photoresistor Works

- Special semiconductor crystal, such as cadmium sulfide or lead sulfide is used to make photoresistors.
- When this semiconductor is placed in dark, electrons within its structure resist flow through the resistor because they are too strongly bound to the crystal's atoms.
- When this semiconductor is illuminated, incoming photons of light collide with the bound electrons, stripping them from the binding atom, thus creating holes in the process.
- Liberated electrons contribute to the current flowing through the device.

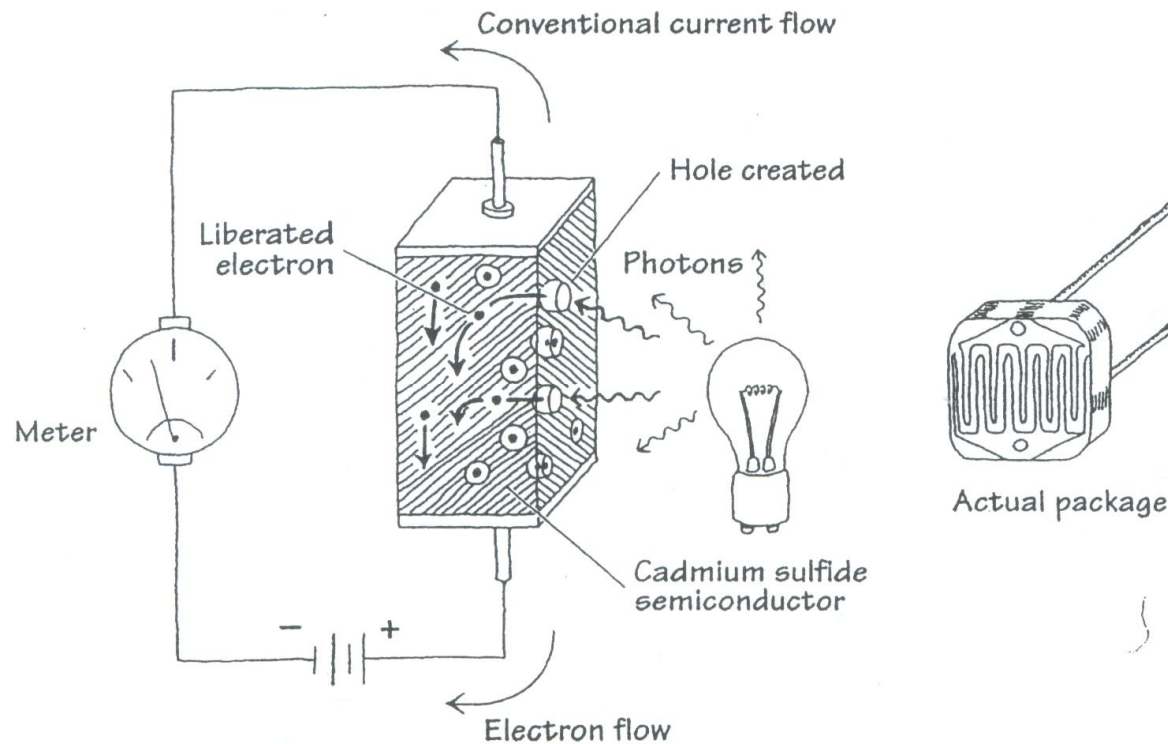

Photoresistor Application —Light Activated Relay

- Light-sensitive voltage divider is being used to trip a relay whenever the light intensity change.
- Light-activated circuit:
 - When the photoresistor is exposed to light, its resistance decreases.
 - → Transistor's base current and voltage increase and if the base current and voltage are large enough, the collector-emitter pair of the transistor conducts triggering the relay.
- The value of R_1 in the light-activated circuit should be around $1\text{ K}\Omega$ but may have to be adjusted.
- Dark-activated relay works in a similar but opposite manner.
- R_1 in the dark-activated circuit ($100\text{K}\Omega$) may also have to be adjusted.
- A 6 to 9-V relay with a 500Ω coil can be used in either circuit.

Light-Activated Relay

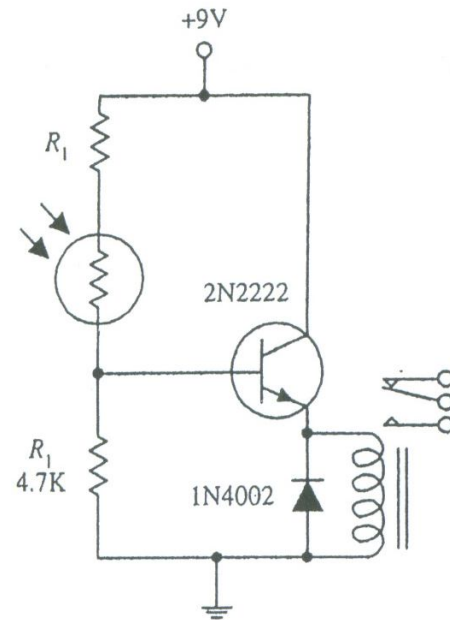

Light activated relay

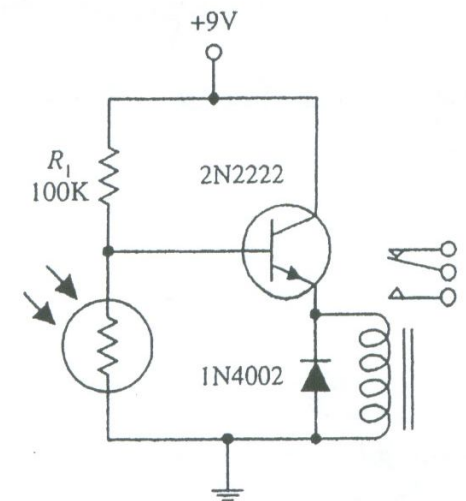

Dark activated relay

Photodiode

- Photodiode is a 2 lead semiconductor device that transforms light energy to electric current.
- Suppose anode and cathode of a photodiode are wired to a current meter.
 - When photodiode is placed in dark, the current meter displays zero current flow.
 - When the photodiode is exposed to light, it acts as a current source, causing current flow from cathode to anode of photodiode through the current meter.
- Photodiodes have very linear light v/s current characteristics.
 - Commonly used as light meters in cameras.
- Photodiodes often have built-in lenses and optical filters.
- Response time of a photodiode slows with increasing surface area.
- Photodiodes are more sensitive than photoresistor.

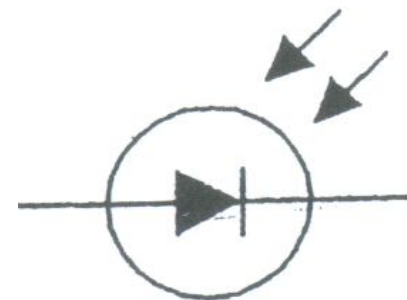
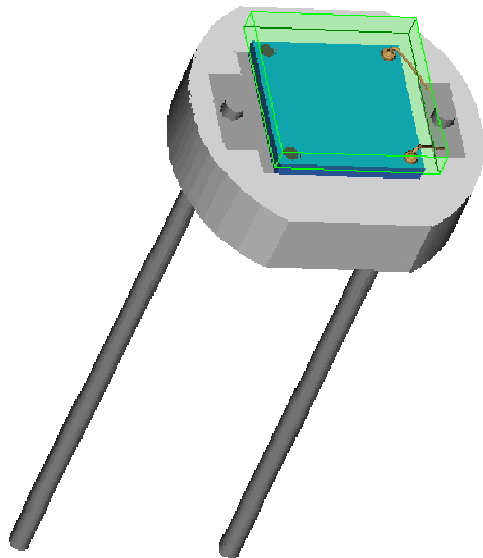

Symbol

How Photodiode Works

- Photodiode: A thin n-type semiconductor sandwiched with a thicker p-type semiconductor.
- N-side is cathode, p-side is anode.
- Upon illumination, a # of photons pass from the n-side and into the p-side of photodiode.
 - Some photons making it into p-side collide with bound electrons within p-semiconductor, ejecting them and creating holes.
 - If these collisions are close to the pn-interface, the ejected electrons cross the junction, yielding extra electrons on the n-side and extra holes on the p-side.
 - Segregation of +ve and -ve charges leads to a potential difference across the pn-junction.
 - When a wire is connected between the cathode and anode, a conventionally positive current flow from the anode to cathode

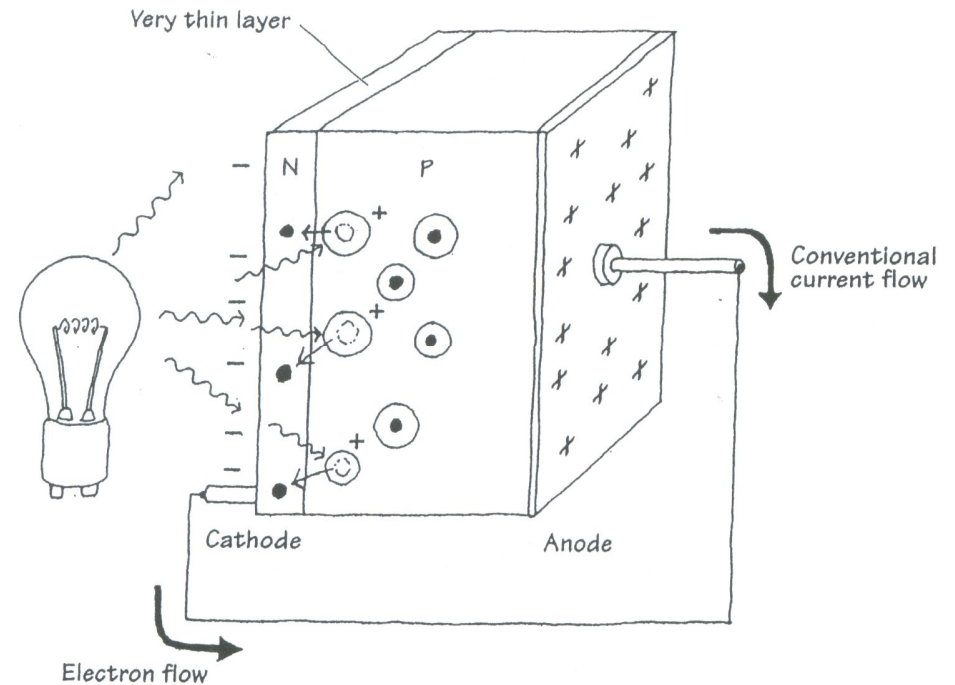

Photodiode Applications—Photovoltaic Current Source

- Photodiode converts light energy directly into electric current that can be measured with meter.
- The input intensity of light and the output current are nearly linear.

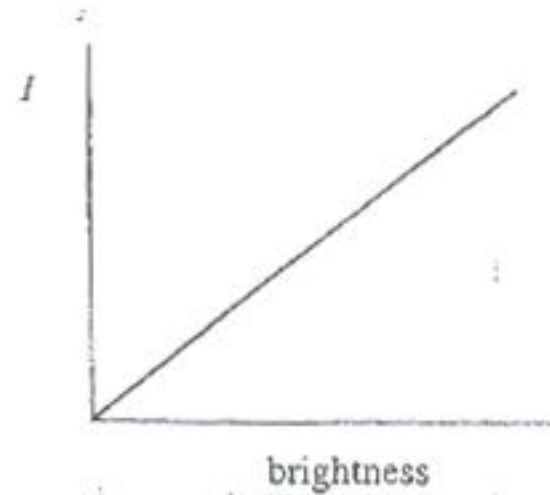
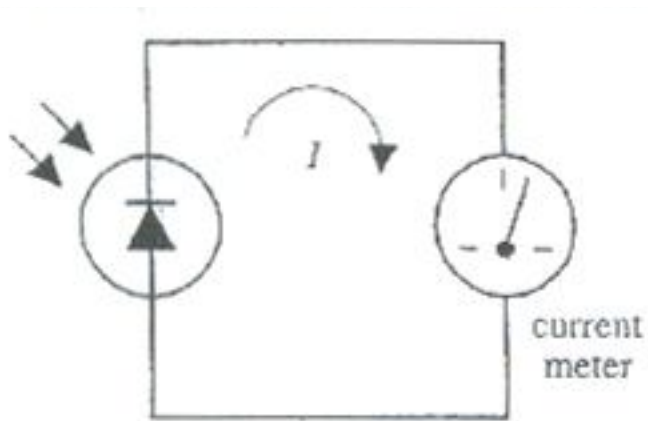

Solar Cell—I

- Solar cells are photodiodes with very large surface areas.
- Compared to usual photodiodes, the large surface area in photodiode of a solar cell yields
 - a device that is more sensitive to incoming light.
 - a device that yields more power (larger current/volts).
- Solar cells yield more power.
- A single solar cell may provide up to 0.5V that can supply 0.1A when exposed to bright light.

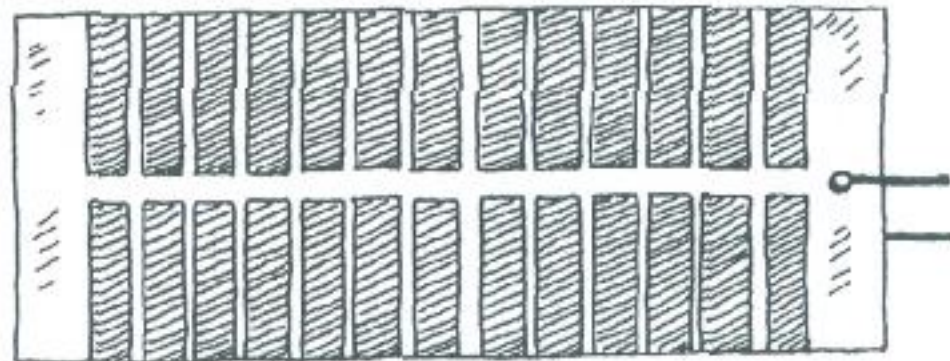
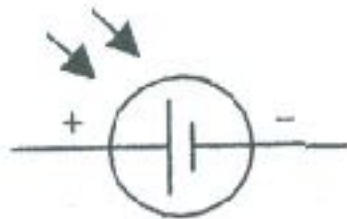

Solar Cell—II



Solar Cell Basic Operation—Power Sources

INCREASED VOLTAGE

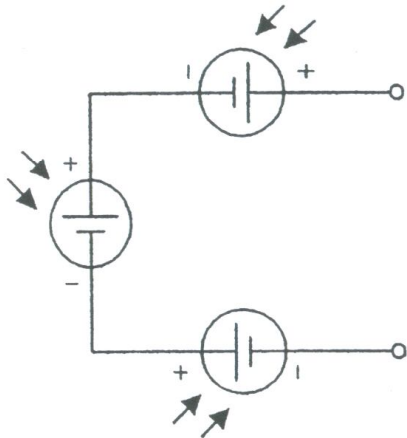

INCREASED CURRENT

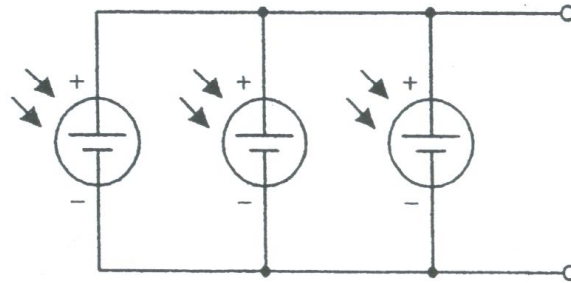

- Each solar cell produces an open-circuit voltage from around 0.45 to 0.5 V and may generate as much as 0.1 A in bright light.
- Similar to batteries, solar cells can be combined in series or parallel.
- Adding cells in series, yields output voltage that is the sum of the individual cell voltages.
- Adding solar cells in parallel, yields an increased output current *vis-à-vis* a single solar cell.

Solar Cell Basic Operation—Battery Charger

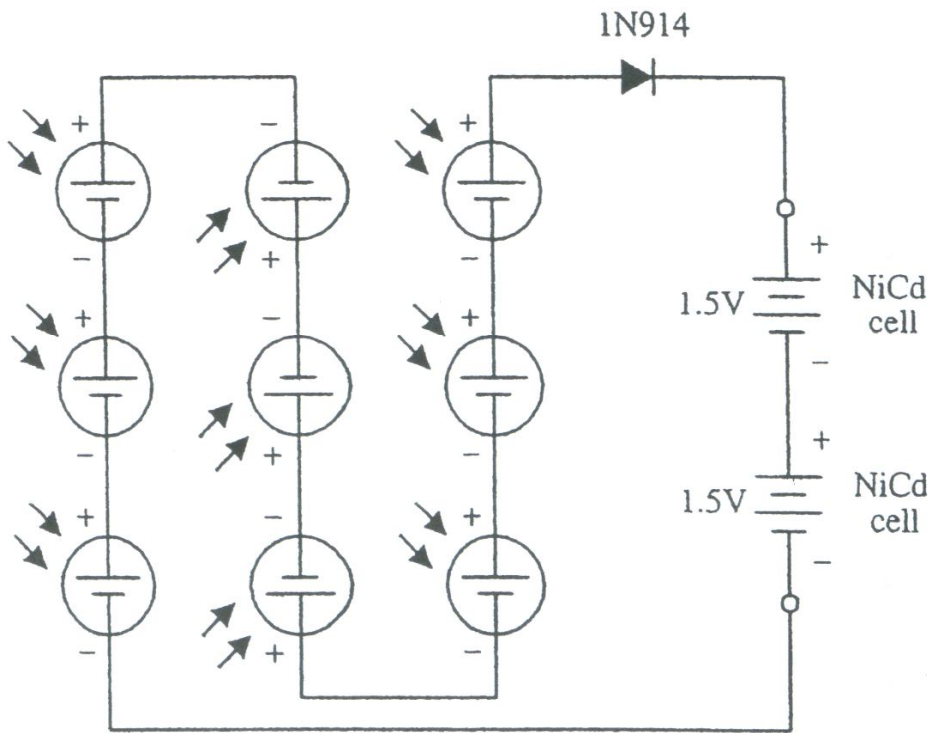

- Nine solar cells placed in series can be used to recharge two 1.5 V NiCd cells.
- The diode is added to the circuit to prevent the NiCd cells from discharging through the solar cell during times of darkness.
- It is important not to exceed the safe charging rate of NiCd cells. To slow the charge rate, a resistor can be placed in series with the batteries.

Phototransistor

- Phototransistor is a light sensitive transistor.
- In one common type of phototransistor, the base lead of a BJT is replaced by a light sensitive surface.
- When the light sensitive surface @ the base is kept in darkness, the collector-emitter pair of the BJT does not conduct.
- When the light sensitive surface @ the base is exposed to light, a small amount of current flows from the base to the emitter. The small base-emitter current controls the larger collector-emitter current.
- Alternatively, one can also use a field-effect phototransistor (Photo FET).
 - In a photo FET, the light exposure generates a gate voltage which controls a drain-source current.

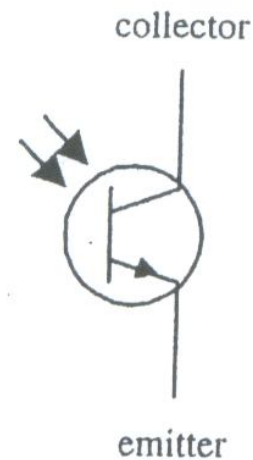

Phototransistor

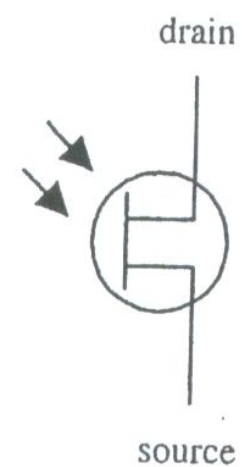
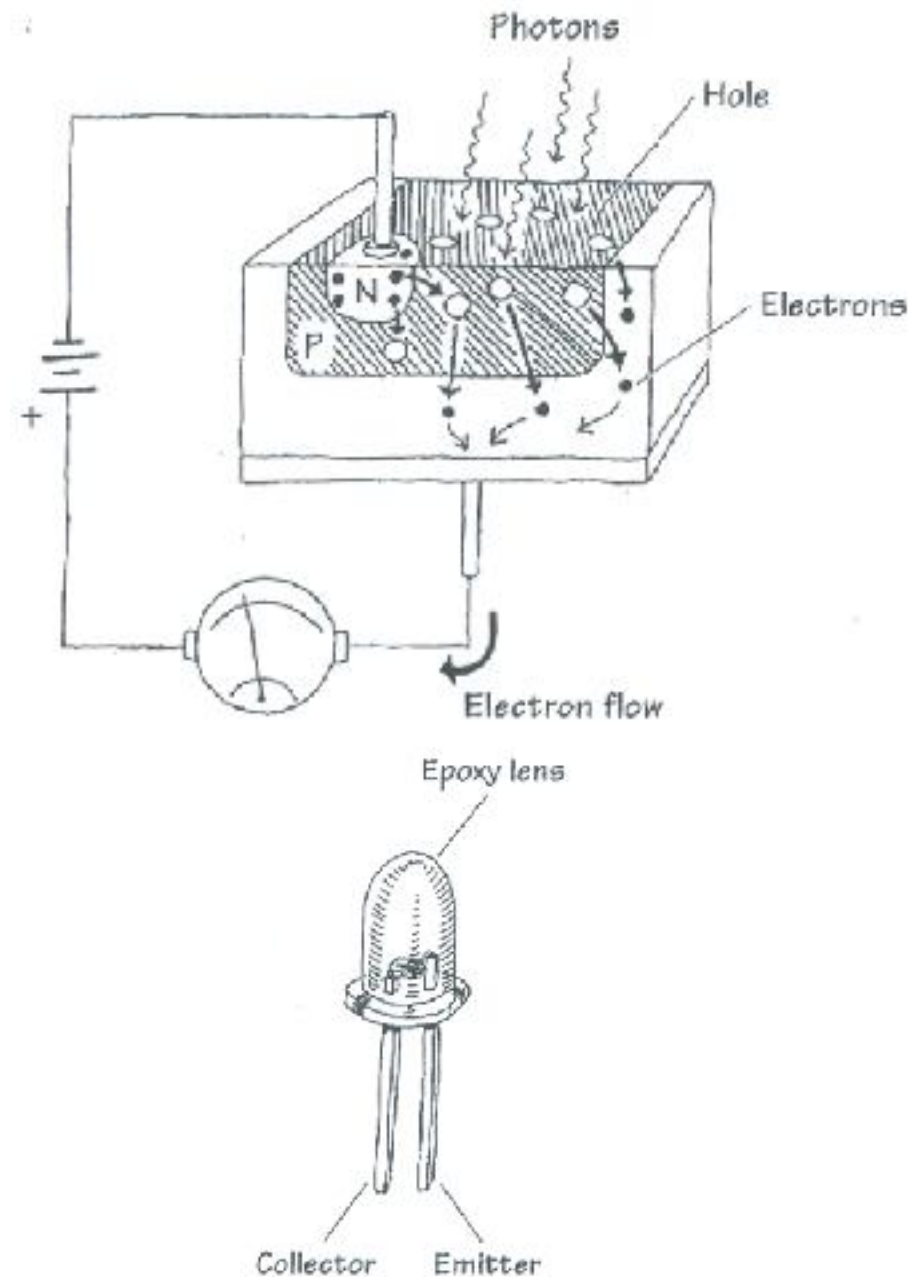

Photo FET

How Phototransistor Works

- The bipolar phototransistor resembles a bipolar transistor that has extra large p-type semiconductor region that is open for light exposure.
- When photons from a light source collide with electrons within the p-type semiconductor, they gain enough energy to jump across the pn-junction energy barrier—provided the photons are of the right frequency/energy.
- As electrons jump from the p-region into the lower n-region, holes are created in the p-type semiconductor.
- The extra electrons injected into the lower n-type slab are drawn toward the positive terminal of the battery, while electrons from the negative terminal of the battery are drawn into the upper n-type semiconductor and across the np junction, where they combine with the holes, the net result is an electrons current that flows from the emitter to the collector.



Phototransistor Applications—Light Activated Relay

- A phototransistor is used to control the base current supplied to a power-switching transistor that is used to supply current to a relay.
- When light comes in contact with the phototransistor, the phototransistor turns on, allowing current to pass from the supply into the base of the power-switching transistor.
- This allows the power-switching transistor to turn on, and current flows through the relay, triggering it to switch states.
- The 100K pot is used to adjust the sensitivity of device by controlling current flow through the phototransistor.

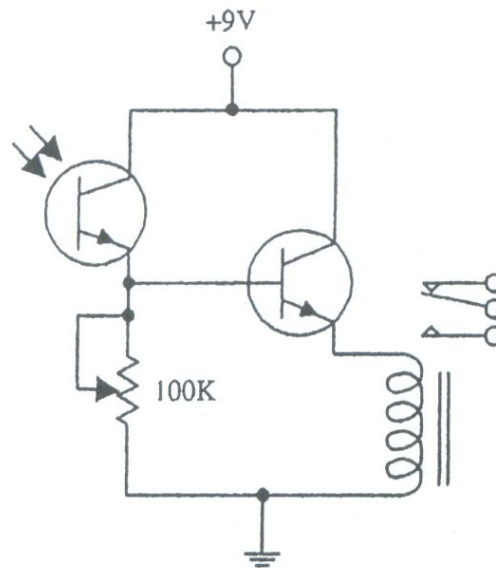

Phototransistor Applications—Dark Activated Relay

- A phototransistor is used to control the base current supplied to a power-switching transistor that is used to supply current to a relay.
- When light is removed from the phototransistor, the phototransistor turns off, allowing more current to enter into the base of the power-switching transistor.
- This allows the power-switching transistor to turn on, and current flows through the relay, triggering it to switch states.
- The 100K pot is used to adjust the sensitivity of device by controlling current flow through the phototransistor.

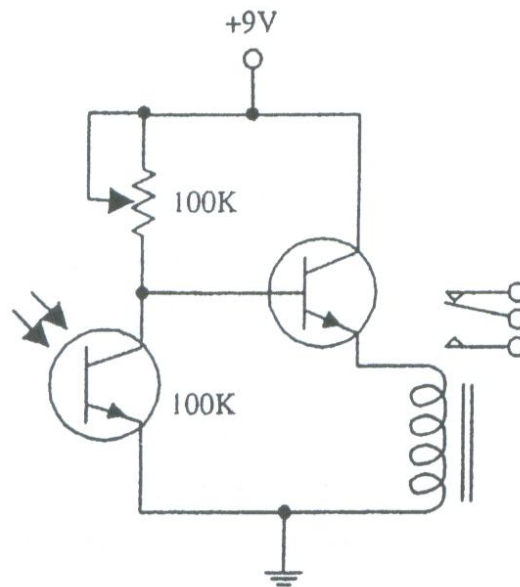

Phototransistor Applications—Tachometer

- A phototransistor is being used as a frequency counter or tachometer.
- A rotating disk is connected to a rotating shaft. The rotating disk has one hole in it.
- For the given setup, the disk will allow light to pass through the hole once every revolution.
- The light passing through the disk triggers the phototransistor into conduction.
- A frequency counter is used to count the number of electrical pulses generated.

